

BEST MANAGEMENT PRACTICES FOR CONSTRUCTION ACTIVITIES

CITY OF DRAPER
ENGINEERING DIVISION
APPROVED
SWPPP PLANS & DOCUMENTS



This manual is intended as guidance for implementing stormwater Best Management Practices at construction sites. It does not represent all BMPs, but rather a presentation of the more common ones. Please refer to Salt Lake County's Guidance *Document for Stormwater Management* at www.pweng.slco.org/strm/html/guide.html for a complete list and more information.

Salt Lake County cannot be held liable for special, collateral, incidental or consequential damages in connection with or arising from using techniques presented in this manual.

First Printing – July 6, 1994

Second Printing – February 2007



STORMWATER AND CONSTRUCTION ACTIVITIES

A landowner or primary contractor who plans a construction activity which will disturb one or more acres of land, is required to obtain a permit from the Utah Division of Water Quality. The permit may be obtained on-line at www.waterquality.utah.gov/updes/stormwater. Please note that the permit is required **BEFORE** construction starts. The permit requires the development and implementation of a Storm Water Pollution Prevention Plan (SWPPP) that identifies potential sources of stormwater pollutants and Best Management Practices (BMPs) to reduce or eliminate their impacts.

BMPs are practices that control stormwater sediment and erosion to the maximum extent practicable. These controls include a wide range of structural and non-structural options. This booklet presents BMPs that are recommended by the Utah Division of Water Quality and the Environmental Protection Agency. A Guidance Document for Stormwater Management provides information on additional BMPs and is available on-line at www.pweng.slco.org/strm/html/guide.html.

Contractors may use this booklet as general guidance related to BMPs; it is up to the contractor to select appropriate BMPs and implement and maintain these BMPs. Selection of BMPs will be site specific and deviation from those presented here may be appropriate given the conditions, contractor experience and new technology. Variations are acceptable provided implemented controls meet the intent of the BMP.

ADDITIONAL INFORMATION

Salt Lake County Stormwater Coalition

<http://www.stormwatercoalition.org/>

Salt Lake County Department Flood Control Engineering

<http://www.pweng.slco.org/flood/index.html>

Salt Lake County Public Works Stormwater Management

www.pweng.slco.org/strm/html/guide.html

State Division of Water Quality

<http://www.waterquality.utah.gov/UPDES/stormwater.htm>

US Environmental Protection Agency

http://cfpub1.epa.gov/npdes/home.cfm?program_id=6

Center for Watershed Protection

<http://www.cwp.org/>

Low Impact Development

<http://www.lid-stormwater.net/>

StormCon

<http://www.forester.net/sc.html>

Water Environment Federation

<http://www.wef.org/Home>

Stormwater Authority

<http://www.stormwaterauthority.org/>

TABLE OF CONTENTS

Selection of BMPs	i
Benching.....	1
Bioengineering.....	2
Building Repair, Remodeling, and Construction.....	3
Check Dams	4
Chemical Mulch	5
Compaction	6
Concrete Waste Management	7
Construction Road Stabilization	8
Construction Sequencing.....	9
Contaminated or Erodible Surface Areas.....	10
Diversion Dike.....	11
Dust Controls	12
Earth Berm Barrier	13
Employee Training	14
Equipment & Vehicle Wash Down Area	15
Erosion Control Blanket	16
Filter Strips	17
Floatation Silt Curtain.....	18
Geotextiles and Mats	19
Hazardous Waste Management.....	20
Hydromulching	21
Inlet Protection – Concrete Block.....	22
Inlet Protection – Excavated	23
Inlet Protection – Gravel	24
Inlet Protection – Silt Fence/Straw Bale	25
Inlet Protection – Wattle.....	26
Inspection & Maintenance.....	27
Land Grading	28
Material Storage	29
Material Use	30
Mulching	31
Outlet Protection	32
Portable Toilets.....	33
Preservation of Existing Vegetation	34
Sandbag Barrier.....	35
Sediment Basin.....	36
Sediment Trap	37
Silt Fence.....	38
Slope Drain	39
Spill Clean-up	40

TABLE OF CONTENTS

(continued)

Stabilized Construction Entrance 41
Straw Bale Barrier..... 42
Street Sweeping 43
Surface Roughening 44
Temporary and Permanent Seeding and Planting 45
Temporary Drains and Swales 46
Temporary Stream Crossing 47
Vehicle and Equipment Cleaning 48
Vehicle and Equipment Fueling 49
Vegetated Buffers 50
Waste Disposal..... 51

SELECTION OF BEST MANAGEMENT PRACTICES

Good Housekeeping & Waste Containment

Building Repair, Remodeling, and Construction
 Chemical Mulch
 Concrete Waste Management
 Construction Road Stabilization
 Contaminated or Erodible Surface Areas
 Diversion Dike
 Dust Controls
 Earth Berm Barrier
 Employee Training
 Equipment & Vehicle Wash Down Area
 Floatation Silt Curtain
 Hazardous Waste Management
 Inspection & Maintenance
 Material Storage
 Material Use
 Mulching
 Portable Toilets
 Spill Cleanup
 Stabilized Construction Entrance
 Street Sweeping
 Temporary Stream Crossing
 Vehicle and Equipment Cleaning
 Vehicle and Equipment Fueling
 Waste Disposal

Minimize & Stabilize Disturbed Areas

Benching
 Bioengineering
 Check Dams
 Chemical Mulch
 Compaction
 Construction Road Stabilization
 Construction Sequencing
 Dust Controls
 Employee Training
 Erosion Control Blankets
 Filter Strips
 Geotextiles and Mats
 Hydromulching
 Inspection & Maintenance
 Land Grading
 Mulching
 Preservation of Natural Vegetation
 Silt Fence
 Straw Bale Barrier
 Surface Roughening
 Temporary & Permanent Seeding & Planting
 Temporary Stream Crossing
 Vegetated Buffers

Protect Slope & Channels

Benching
 Bioengineering
 Check Dams
 Chemical Mulch
 Construction Road Stabilization
 Diversion Dike
 Employee Training
 Erosion Control Blankets
 Filter Strips
 Geotextile Mats
 Hydromulching
 Inspection & Maintenance
 Land Grading
 Mulching
 Outlet Protection
 Preservation of Natural Vegetation
 Sand Bag Barrier
 Silt Fence
 Slope Drain
 Straw Bale Barrier
 Surface Roughening
 Temporary & Permanent Seeding & Planting
 Temporary Stream Crossing
 Vegetated Buffers

Control Internal Erosion & Site Perimeter

Bioengineering
 Chemical Mulch
 Diversion Dike
 Earth Berm Barrier
 Employee Training
 Equipment & Vehicle Wash Down
 Filter Strips
 Floatation Silt Curtain
 Geotextiles and Mats
 Inlet Protection - Concrete Block
 Inlet Protection - Excavated
 Inlet Protection - Gravel
 Inlet Protection - SiltFence/Straw Bale
 Inlet Protection - Wattle
 Inspection & Maintenance
 Land Grading
 Outlet Protection
 Preservation of Natural Vegetation
 Sandbag Barrier
 Sediment Basin
 Sediment Trap
 Silt Fence
 Slope Drain
 Stabilized Construction Entrance
 Straw Bale Barrier
 Surface Roughening
 Vegetated Buffers
 Vehicle and Equipment Cleaning

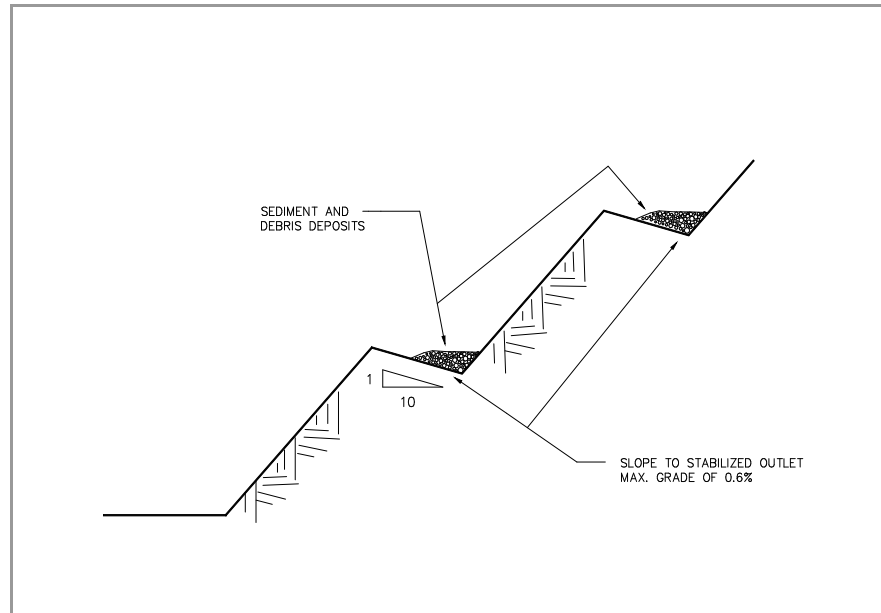
**DESCRIPTION:**

Slope construction with benches spaced at regular intervals perpendicular to the slope which intercept and collect sheet flow and direct it to a stable outfall point.

APPLICATIONS:

- ◆ Unstabilized cut and fill slopes
- ◆ Large stockpiles
- ◆ Existing unstable slopes

INSTALLATION/APPLICATION CRITERIA:

- ◆ Benches should be formed as slope is constructed and graded to the outlet point.
- ◆ Stabilized outlet with sediment controls should be in place prior to slope construction.

LIMITATIONS:

- ◆ Construction slope design must accommodate benching
- ◆ Not appropriate for sandy or rocky soil
- ◆ Only effective if suitable outlet provided

MAINTENANCE:

- ◆ Inspect after major storm events and at least biannually, repair any damaged areas.
- ◆ Remove debris blocking water flow.
- ◆ Inspect outlet, repair/replace sediment controls and remove sediment build up.

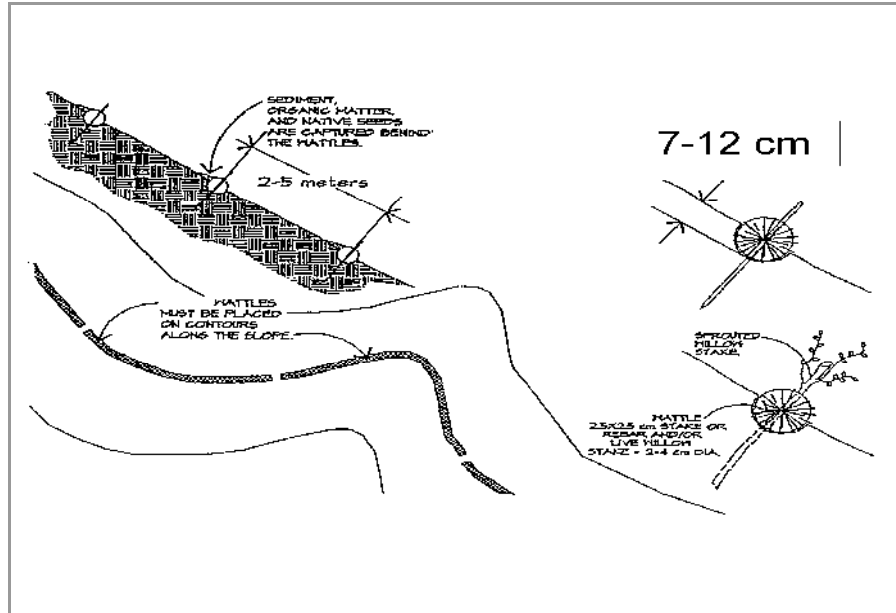

DESCRIPTION:

Bioengineering methods combine vegetative and mechanical techniques to stabilize eroding slopes. Bioengineering methods include sprigging, tubelings and wattling. Sprigging involves planting rhizomes, stolons, shoots or sprouts of a desirable species. Tubelings are forbs, shrubs, or trees commercially available in reusable plastic tubes or sleeves. Wattles are bundles of cuttings from live willows, alders, or similar plants placed and secured in trenches across a slope to aid in slope stabilization.

APPLICATIONS:

- ◆ Sprigging may be performed on cut and fill slopes or other areas needing permanent soil stability.
- ◆ Tubelings may be placed on any area needing revegetation, but are most useful on slopes or flat areas where poor topsoil conditions inhibit successful seed germination and early plant growth.
- ◆ Wattles act to reduce slope length and aid in stabilizing slopes due to surface runoff, frost heaving, needle ice, or other soil movement.

INSTALLATION/APPLICATION CRITERIA:

- ◆ Sprigging involves tearing sod apart; planting rhizomes or stolons, or transplanting shoots or sprouts. Sprigs are placed by broadcast, punching-in or with a special sprig planter.
- ◆ Tubelings involve drilling holes to the depth necessary to accommodate roots.
- ◆ Wattles are best applied to slopes no steeper than 2:1.

LIMITATIONS:

- ◆ Availability of plant materials may affect what species can be used.
- ◆ May be necessary to arrange for commercially grown tubelings.
- ◆ Cannot be used as a substitute for retaining walls or similar devices to stabilize over steepened slopes.

MAINTENANCE:

- ◆ Sprigging and tubeling plantings should be checked periodically until they are permanently established.
- ◆ Assess the need for replacement plantings or supplemental fertilizer.

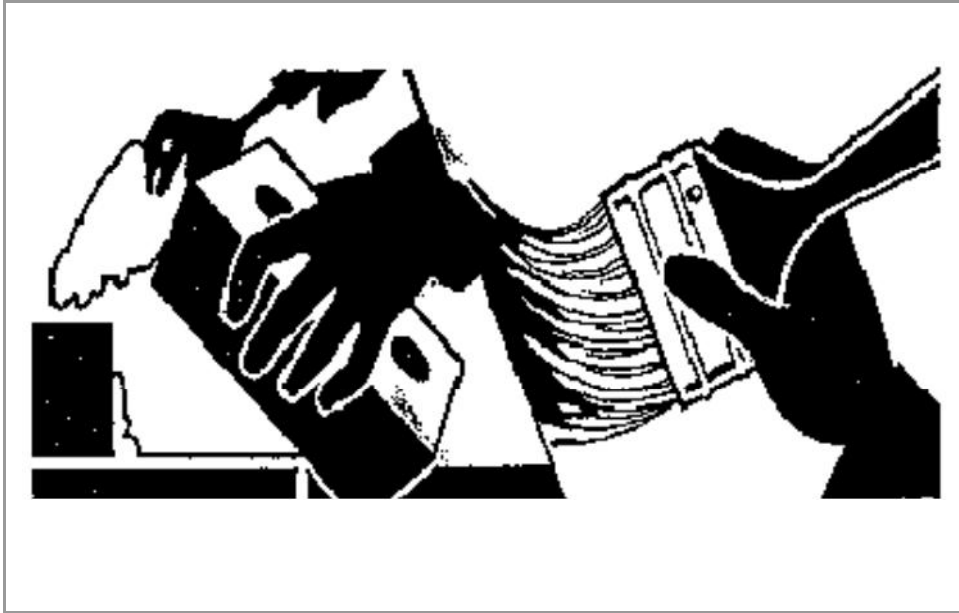
**DESCRIPTION:**

Prevent or reduce the discharge of pollutants to stormwater from building repair, remodeling, and construction by using soil erosion controls, enclosing or covering building material storage areas, using good housekeeping practices, using safer alternative products, and training employees.

APPLICATIONS:

- ◆ Use soil erosion control techniques if bare ground is temporarily exposed.
- ◆ Use permanent soil erosion control techniques if the remodeling clears buildings from an area that are not to be replaced.

INSTALLATION/APPLICATION CRITERIA:

- ◆ Enclose painting operations consistent with local air quality regulations and OSHA.
- ◆ Properly store materials that are normally used in repair and remodeling such as paints and solvents.
- ◆ Properly store and dispose waste materials generated from the activity.
- ◆ Maintain good housekeeping practices while work is underway.

LIMITATIONS:

- ◆ This BMP is for minor construction only.
- ◆ A licensed hazardous waste hauler must dispose of hazardous waste that cannot be re-used or recycled.
- ◆ Safer alternative products may not be available, suitable, or effective in every case.
- ◆ Be certain that actions to help storm water quality are consistent with OSHA and air quality regulations.

MAINTENANCE:

None

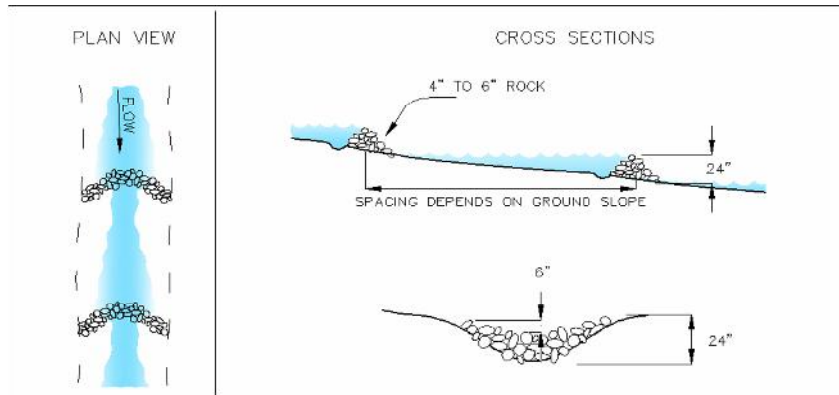
**DESCRIPTION:**

A small, temporary dam constructed across a drainage ditch to reduce velocity of concentrated storm water flows, thereby reducing the erosion of the ditch.

APPLICATIONS:

- ◆ Temporary drainage paths
- ◆ Permanent drainage ways not yet stabilized
- ◆ Existing drainage paths receiving increased flows due to construction

INSTALLATION/APPLICATION CRITERIA:

- ◆ Prepare location of dam by removing any debris and rough grading any irregularities in channel bottom
- ◆ Place rocks by hand or with appropriate machinery; do not dump
- ◆ Space dams to make the base of the upstream dam the same elevation as the top of the next lower dam
- ◆ Construct dam to pass design flows with center lower to create a weir effect
- ◆ Construct 50% side slopes on dam

LIMITATIONS:

- ◆ Maximum recommended drainage area is 10 acres
- ◆ Maximum recommended height is 24"
- ◆ Do not use in running stream

MAINTENANCE:

- ◆ Inspect dams at a minimum of twice monthly, after each major rain event, and daily during prolonged rainfall.
- ◆ Remove any large debris and repair any damage to dam, channel or sideslopes.
- ◆ Remove accumulated sediment when it reaches one half the height of the dam.

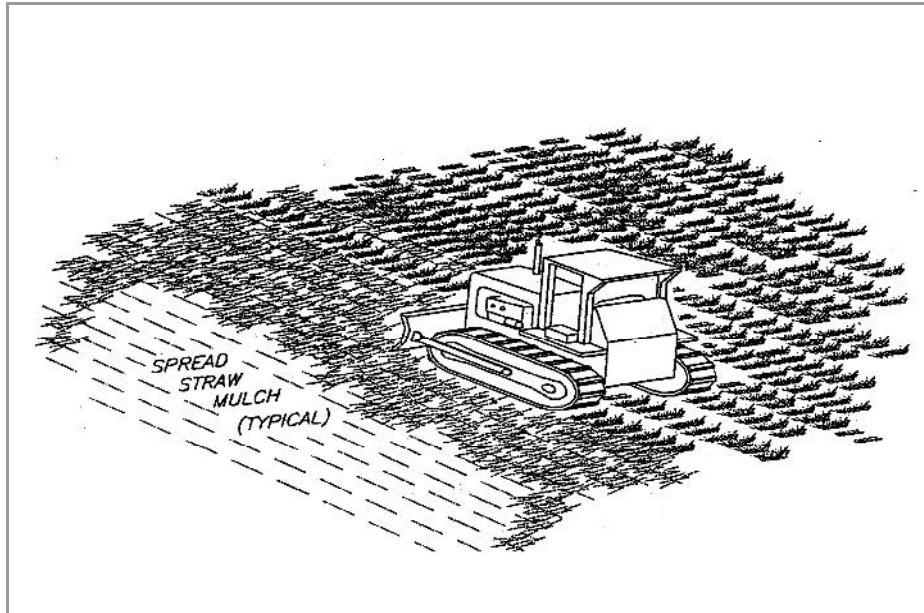
**DESCRIPTION:**

Applying materials such as vinyl, asphalt, plastics, or rubber on an unprotected slope to temporarily stabilize the slope.

APPLICATIONS:

- ◆ As a tacking agent to aid the stabilization of mulches (where matting is not used).
- ◆ As a short-term alternative in areas where temporary seeding practices cannot be used because of seasonal condition or climate.
- ◆ On steep and rocky slopes where neither mechanical methods or mulches and protective netting can be effectively applied.

INSTALLATION/APPLICATION CRITERIA:

- ◆ The application rates and procedures recommended by the manufacturer of a chemical stabilization product should be followed to prevent the products from forming ponds and from creating large areas where moisture cannot get through.
- ◆ For permanent application, chemical mulches (when used with seed and mulch) should be applied over wood fiber or straw mulch.

LIMITATIONS:

- ◆ Chemical mulches can create impervious surfaces and impact water quality if not properly applied.
- ◆ Some products may not be suitable for use near live streams.

MAINTENANCE:

- ◆ Inspect at regular intervals and after each runoff-producing storm event.
- ◆ Replace chemical mulch as needed to ensure adequate level of coverage.

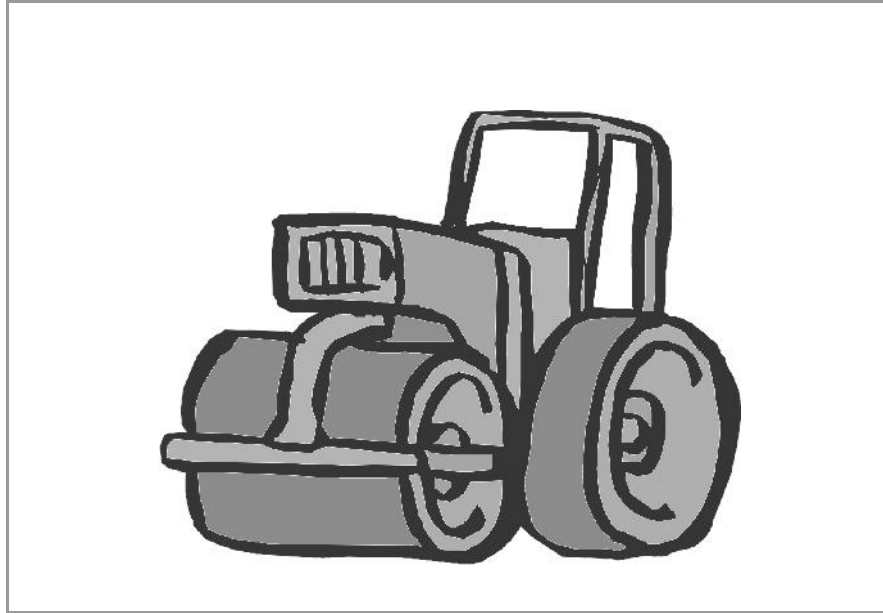
**DESCRIPTION:**

Use of rolling, tamping, or vibration to stabilize fill materials and control erosion by increasing the soil density. Increasing the density of soil improves soil strength, reduces long-term soil settlement, and provides resistance to erosion.

APPLICATIONS:

- ◆ Stabilize fill material placed around various structures.
- ◆ Improve soil in place as foundation support for roads, parking lots, and buildings.

INSTALLATION/APPLICATION CRITERIA:

- ◆ Make sure soil moisture content is at optimum levels.
- ◆ Use proper compaction equipment.
- ◆ Install sediment control and storm water management devices below compacted areas and runoff interceptor devices above these areas. Drainage from compacted areas must be carefully planned to protect adjacent uncompacted soils.
- ◆ The surface of compacted areas should be scarified and seeded or mulched and seeded to increase the effectiveness of compaction.

LIMITATIONS:

- ◆ Compaction tends to increase runoff.
- ◆ Over-compaction will hamper revegetation efforts.

MAINTENANCE:

- ◆ No maintenance required.

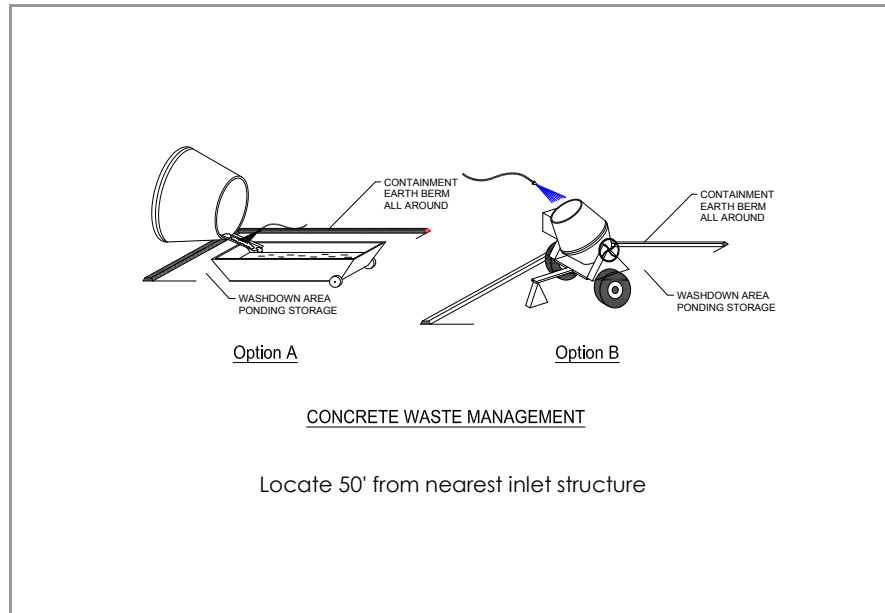

DESCRIPTION:

Prevent or reduce the discharge of pollutants to storm water from concrete waste by conducting washout off-site, performing on-site washout in a designated area, and training employees and subcontractors.

APPLICATION:

This technique is applicable to all types of sites.

INSTALLATION/APPLICATION CRITERIA:

- ◆ Store dry materials under cover, away from drainage areas.
- ◆ Minimize excess mixing of fresh concrete, mortar or cement on-site.
- ◆ Perform washout of concrete trucks off-site or in designated areas only.
- ◆ Do not wash out concrete trucks into storm drains, open ditches, streets, or streams.
- ◆ Do not allow excess concrete to be dumped on-site, except in designated areas.
- ◆ When washing concrete to remove fine particles and expose the aggregate, avoid creating runoff by draining the water within a bermed or level area. (6" tall by 6" wide).
- ◆ Train employees and subcontractors in proper concrete waste management.

LIMITATIONS:

- ◆ Off-site washout of concrete wastes may not always be possible.

MAINTENANCE:

- ◆ Inspect subcontractors to ensure that concrete wastes are being properly managed.
- ◆ If using a temporary pit, dispose hardened concrete on a regular basis.

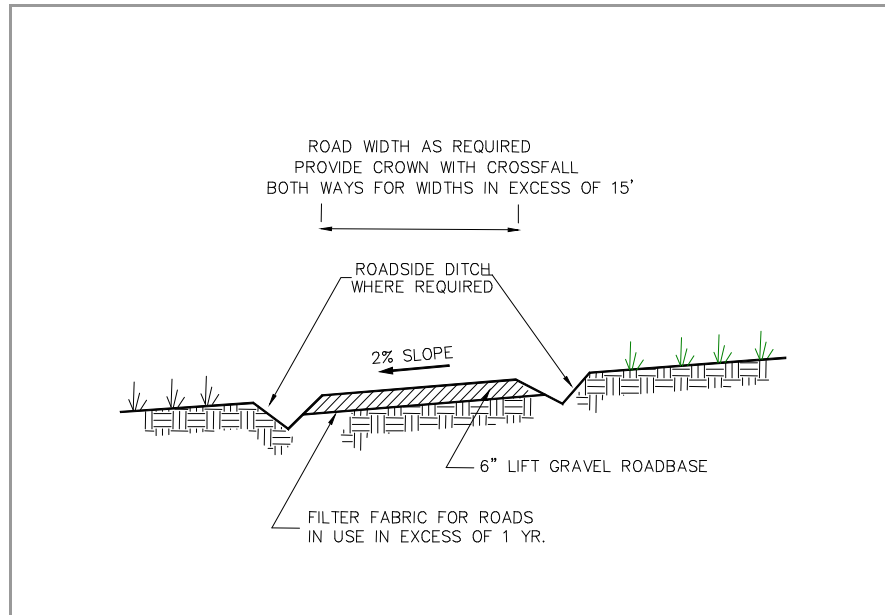
**DESCRIPTION:**

Temporary stabilization of on-site roadway by placement of gravel roadbase.

APPLICATION:

- ◆ On-site roadways used daily by construction traffic (may not apply to gravelly type soils).
- ◆ Parking or staging areas susceptible to erosion due to traffic use.

INSTALLATION/APPLICATION CRITERIA:

- ◆ Grade temporary access road with 2% cross fall, for two-way width provide crown.
- ◆ Provide roadside ditch and outlet controls where required.
- ◆ Place 6 inches of 2-inch to 4-inch crushed rock on driving area.

LIMITATIONS:

- ◆ May require removal of gravel roadbase at completion of activities if final cover is not impervious.
- ◆ May require controls for surface storm water runoff.

MAINTENANCE:

- ◆ Inspect after major rainfall events and at least monthly.
- ◆ Place additional gravel as needed and repair any damaged areas.
- ◆ Maintain any roadside drainage controls.



DESCRIPTION:

Construction sequencing is a specified work schedule that coordinates the timing of land-disturbing activities and the installation of erosion and sediment control measures. Construction site phasing involves disturbing only part of a site at a time to prevent erosion from dormant parts. Grading activities and construction are completed and soils are effectively stabilized on one part of the site before grading and construction commence at another part.

APPLICATIONS:

Sequencing can be used to plan earthwork and erosion and sediment control activities at sites where land disturbances might affect water quality in a receiving waterbody.

INSTALLATION/APPLICATION CRITERIA:

Sequencing schedules should include the following Design and Installation Criteria:

- ◆ The erosion & sediment control practices that are to be installed
- ◆ Principal development activities
 - ▶ Which measures should be installed before other activities are started
 - ▶ Compatibility with the general contract construction schedule

LIMITATIONS:

Weather and other unpredictable variables might affect sequence schedules. However, the erosion and sediment control plan should plainly state the proposed schedule and a protocol of making changes due to unforeseen problems.

MAINTENANCE:

Follow the construction sequence throughout the project and modify the written plan before any changes in construction activities are executed. Update the plan if a site inspection indicates the need for additional erosion and sediment control.

**DESCRIPTION:**

Prevent or reduce the discharge of pollutants to stormwater from contaminated or erodible surface areas by leaving as much vegetation on-site as possible, minimizing soil exposure time, stabilizing exposed soils, and preventing stormwater runoff and runoff.

APPLICATIONS:

This BMP addresses soils which are not so contaminated as to exceed criteria but the soil is eroding and carrying pollutants off in the stormwater.

INSTALLATION/APPLICATION CRITERIA:

Contaminated or erodible surface areas can be controlled by:

- ◆ Preservation of natural vegetation, re-vegetation, chemical stabilization, removal of contaminated soils or geosynthetics.

LIMITATIONS:

Disadvantages of preserving natural vegetation or re-vegetating include:

- ◆ Requires substantial planning to preserve and maintain the existing vegetation.
- ◆ May not be cost-effective with high land costs.
- ◆ Lack of rainfall and/or poor soils may limit the success of re-vegetated areas.
- ◆ Disadvantages of chemical stabilization include:
 - Creation of impervious surfaces.
 - May cause harmful effects on water quality.
 - Is usually more expensive than vegetative cover.

MAINTENANCE:

Maintenance should be minimal, except possibly if irrigation of vegetation is necessary.

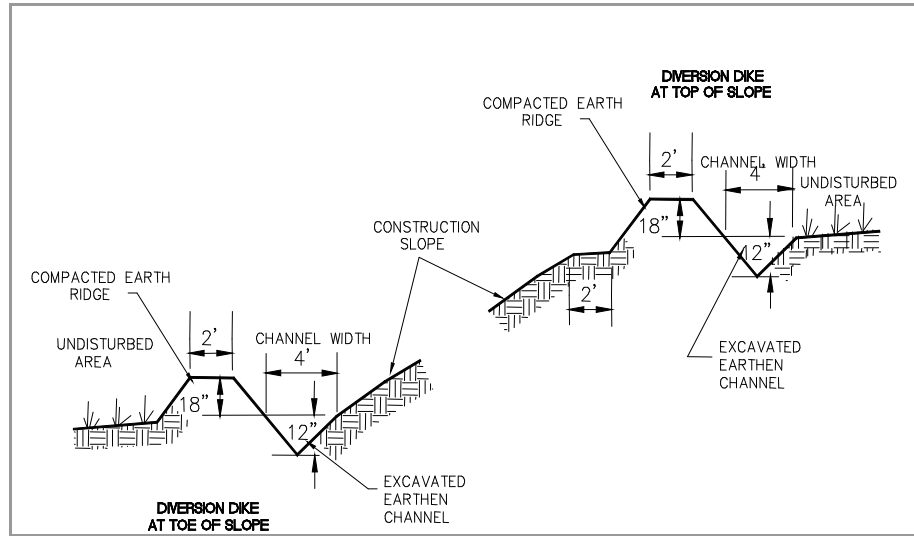

DESCRIPTION:

A temporary sediment barrier and storm runoff conveyance consisting of an excavation channel and compacted earth ridge.

APPLICATION:

- ◆ Construct along top of construction slope to intercept upgradient runoff and convey around construction site.
- ◆ Construct along toe of construction to divert sediment laden runoff.
- ◆ Construct along midpoint of construction slope to intercept runoff and channel to controlled discharge point.
- ◆ Construct around base of soil stockpiles to capture sediment.
- ◆ Construct around perimeter of disturbed areas to capture sediment.

INSTALLATION/APPLICATION CRITERIA:

- ◆ Clear and grub area for dike construction.
- ◆ Excavate channel and place soil on downgradient side.
- ◆ Shape and machine compact excavated soil to form ridge.
- ◆ Place erosion protection (riprap, mulch) at outlet.
- ◆ Stabilize channel and ridge as required with mulch, gravel, or vegetative cover.

LIMITATIONS:

- ◆ Recommended maximum drainage area of 5 acres.
- ◆ Recommended maximum sideslopes of 2h:1v (50%).
- ◆ Recommended maximum slope on channel of 1%.

MAINTENANCE:

- ◆ Inspect immediately after any rainfall and at least daily during prolonged rainfall.
- ◆ Look for runoff breaching dike or eroding channel or sideslopes.
- ◆ Check discharge point for erosion or bypassing of flows.
- ◆ Repair and stabilize as necessary.
- ◆ Inspect daily during vehicular activity on slope, check for and repair any traffic damage.

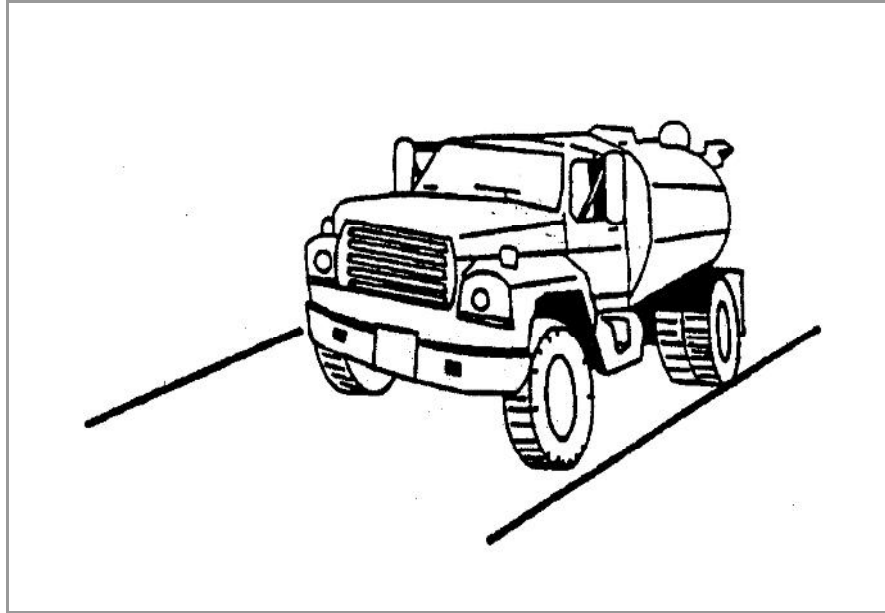
**DESCRIPTION:**

Dust control measures are used to stabilize soil from wind erosion, and reduce dust by construction activities.

APPLICATION:

Dust control is useful in any process area, loading and unloading area, material handling areas, and transfer areas where dust is generated. Street sweeping is limited to areas that are paved.

INSTALLATION/APPLICATION CRITERIA:

- ◆ Mechanical dust collection systems are designed according to the size of dust particles and the amount of air to be processed. Manufacturers' recommendations should be followed for installation (as well as the design of the equipment).
- ◆ Two kinds of street sweepers are common: brush and vacuum. Vacuum sweepers are more efficient and work best when the area is dry.
- ◆ Mechanical equipment should be operated according to the manufacturers' recommendations and should be inspected regularly.

LIMITATIONS:

- ◆ Generally more expensive than manual systems.
- ◆ May be impossible to maintain by plant personnel (the more elaborate equipment).
- ◆ Labor and equipment intensive and may not be effective for all pollutants (street sweepers).

MAINTENANCE:

If water sprayers are used, dust-contaminated waters should be collected and taken for treatment. Areas will probably need to be resprayed to keep dust from spreading.

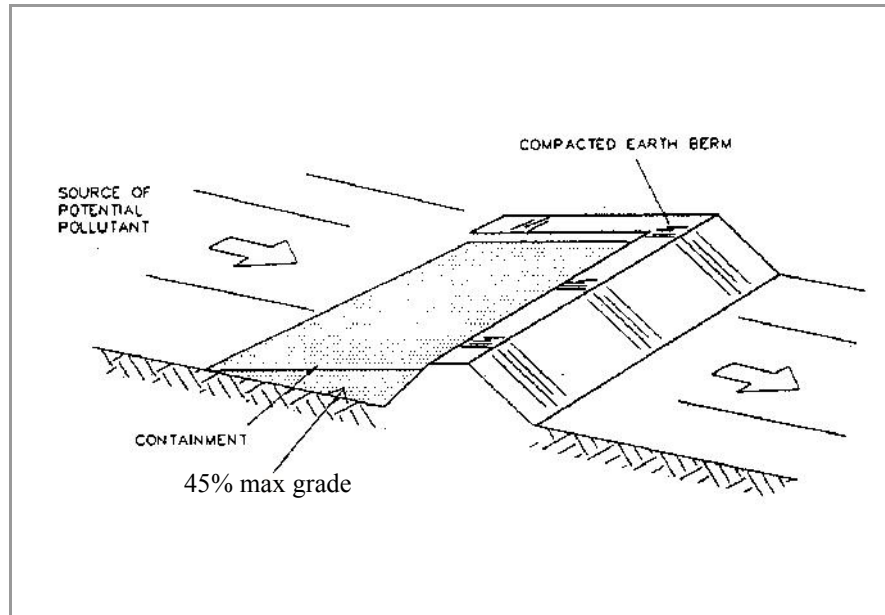
**DESCRIPTION:**

A temporary containment control constructed of compacted soil.

APPLICATION:

- ◆ Construct around waste and materials storage area.
- ◆ Construct around staging and maintenance areas.
- ◆ Construct around vehicle parking and servicing areas.

INSTALLATION/APPLICATION CRITERIA:

- ◆ Construct an earthen berm down hill of the area to be controlled. The berm should surround fueling facilities and maintenance areas on three sides to provide containment.
- ◆ Berm needs to be a minimum of 1 foot tall by 1 foot wide and be compacted by earth moving equipment.

LIMITATIONS:

- ◆ Not effective on steep slopes.
- ◆ Limits access to controlled area.
- ◆ Personnel need to quickly respond to spills with remedial actions.

MAINTENANCE:

- ◆ Observe daily for any non-stormwater discharge.
- ◆ Look for runoff bypassing ends of berms or undercutting berms.
- ◆ Repair or replace damaged areas of the berm and remove accumulated sediment.
- ◆ Recompact soil around berm as necessary to prevent piping.

**DESCRIPTION:**

Employee training, like equipment maintenance, is a method by which to implement BMPs. Employee training should be used in conjunction with all other BMPs as part of the facility's SWPPP.

The specific employee training aspects of each of the source controls are highlighted in the individual information sheets. The focus of this information sheet is more general, and includes the overall objectives and approach for assuring employee training in stormwater pollution prevention. Accordingly, the organization of this information sheet differs somewhat from the other information sheets in this chapter.

OBJECTIVES:

Employee training should be based on four objectives:

- ◆ Promote a clear identification and understanding of the problem, including activities with the potential to pollute stormwater;
- ◆ Identify solutions (BMPs);
- ◆ Promote employee ownership of the problems and the solutions; and
- ◆ Integrate employee feedback into training and BMP implementation.

APPROACH:

- ◆ Integrate training regarding stormwater quality management with existing training programs that may be required for your business by other regulations.
- ◆ Businesses that are not regulated in Federal, State, or local regulations, may use the information in this handbook to develop a training program to reduce their potential to pollute stormwater.
- ◆ Employee training is a vital component of many of the individual source control BMPs included in this manual.

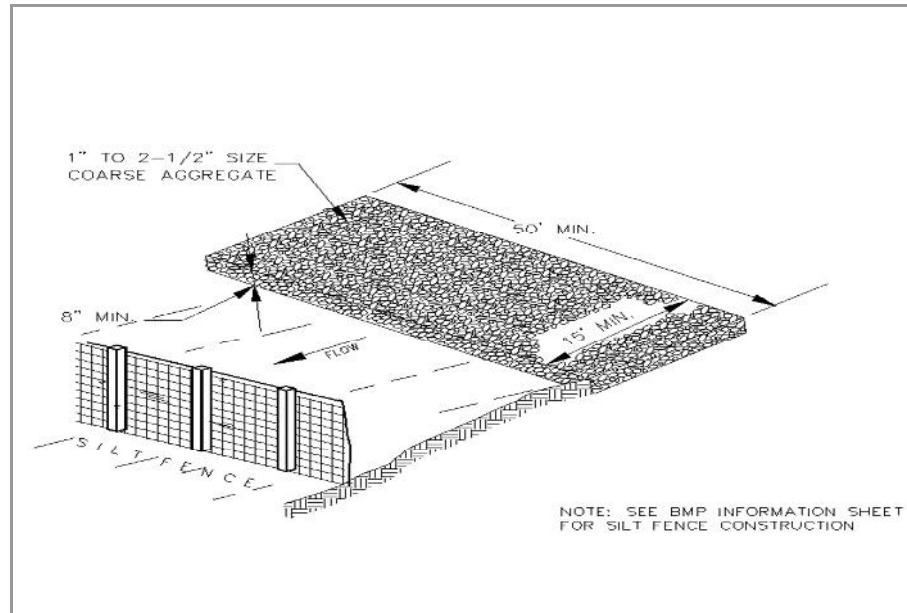
**DESCRIPTION:**

A stabilized pad of crushed stone for general washing of equipment and construction vehicles.

APPLICATION:

At any site where regular washing of vehicles and equipment will occur. May also be used as a filling point for water trucks limiting erosion caused by overflow or spillage of water.

INSTALLATION:

- ◆ Clear and grub area and grade to provide maximum slope of 1%.
- ◆ Compact subgrade and place filter fabric if desired (recommended for wash areas to remain in use for more than 3 months).
- ◆ Place coarse aggregate, 1 to 2-1/2 inches in size, to a minimum depth of 8-inches.
- ◆ Install silt fence downgradient (see silt fence BMP information sheet).

LIMITATIONS:

Cannot be utilized for washing equipment or vehicles that may cause contamination of runoff such as fertilizer equipment or concrete equipment. Solely used to control sediment in wash water.

MAINTENANCE:

- ◆ Inspect daily for loss of gravel or sediment buildup.
- ◆ Inspect adjacent area for sediment deposit and install additional controls as necessary.
- ◆ Repair area and replace gravel as required to maintain control in good working condition.
- ◆ Expand stabilized area as required to accommodate activities.
- ◆ Maintain silt fence as outlined in specific silt fence BMP information sheet.

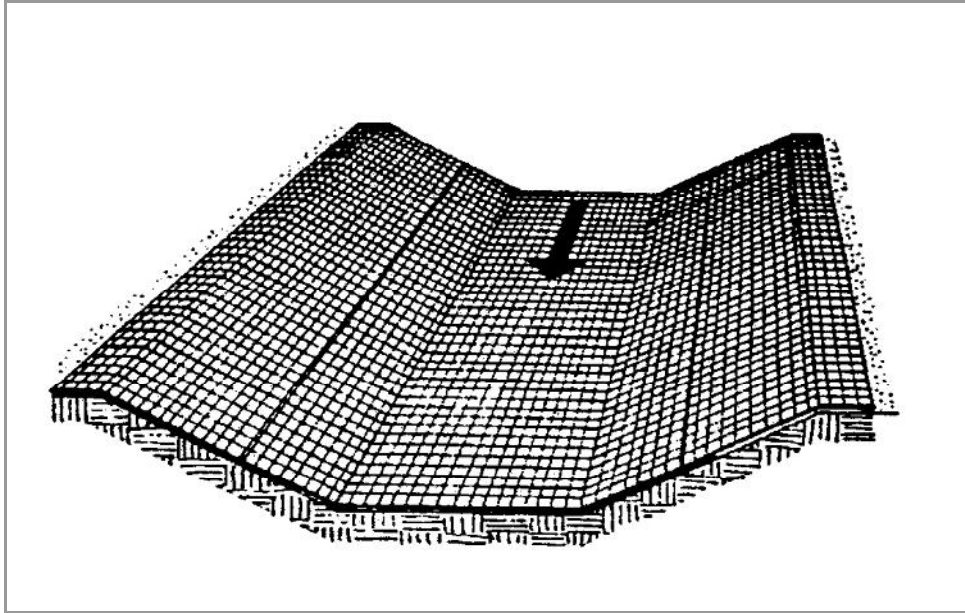
**DESCRIPTION:**

Erosion control blankets are used in place of mulch on areas of high velocity runoff and/or steep grade, to aid in controlling erosion on critical areas by protecting young vegetation.

APPLICATIONS:

- ◆ Where vegetation is likely to grow too slowly to provide adequate cover.
- ◆ In areas subject to high winds where mulch would not be effective.

INSTALLATION/APPLICATION CRITERIA:

- ◆ Install erosion control blankets parallel to the direction of the slope.
- ◆ In ditches, apply in direction of the flow.
- ◆ Place erosion control blankets loosely on soil - do not stretch.
- ◆ Ends of blankets should be buried no less than six inches deep.
- ◆ Staple the edges of the blanket at least every three feet.

LIMITATIONS:

Not recommended in areas which are still under construction.

MAINTENANCE:

- ◆ Check for erosion and undermining periodically, particularly after rainstorms.
- ◆ Repair dislocations or failures immediately.
- ◆ If washouts occur, reinstall after repairing slope damage.
- ◆ Monitor until permanently stabilized.

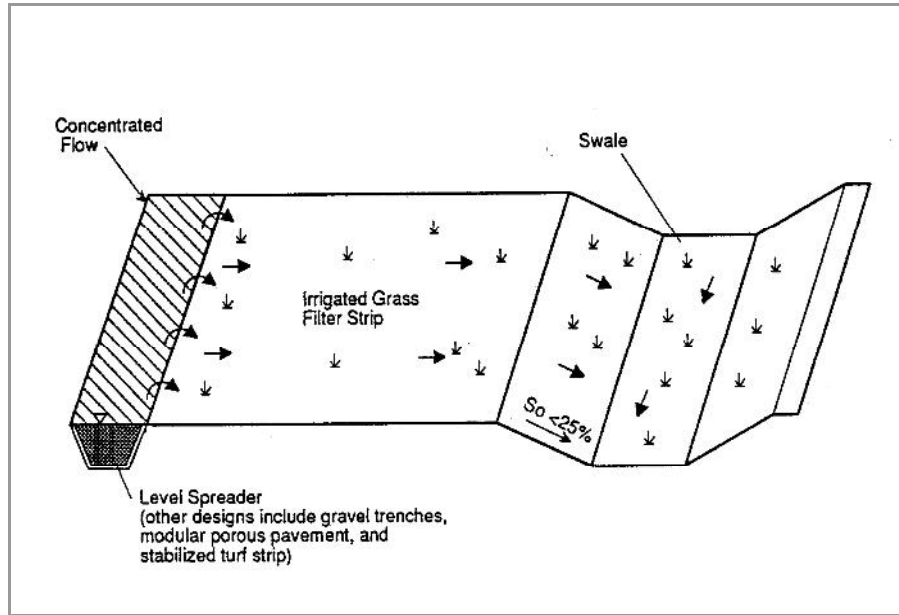

DESCRIPTION:

Filter strips are 20-foot-wide strips of natural or planted vegetation around a construction site. They are designed to cause deposition of sediments within the vegetation layer.

APPLICATIONS:

- ◆ Suited for areas where the soils are well drained or moderately well drained.
- ◆ Areas where the bedrock and the water table are well below the surface.

INSTALLATION/APPLICATION CRITERIA:

- ◆ Make sure the vegetative cover is dense enough to protect underlying soil while causing sediment to settle.
- ◆ Filter strip must be approximately 20 feet wide to function well.
- ◆ The length should be approximately 50 to 75 feet. Where slopes become steeper the length of the strip must be increased.

LIMITATIONS:

- ◆ Only applicable in areas where vegetation is previously established or where sod is added.
- ◆ Vegetated filter strips will not function well on steep slopes, in hilly areas, or in highly paved areas.
- ◆ Sites with slopes of 15 percent or more may not be suitable for filtering storm water flows.

MAINTENANCE:

- ◆ Check for channels and repair.
- ◆ Provide rock aprons to aid in slowing flow if necessary.
- ◆ Maintain vegetation at optimal height and thickness.

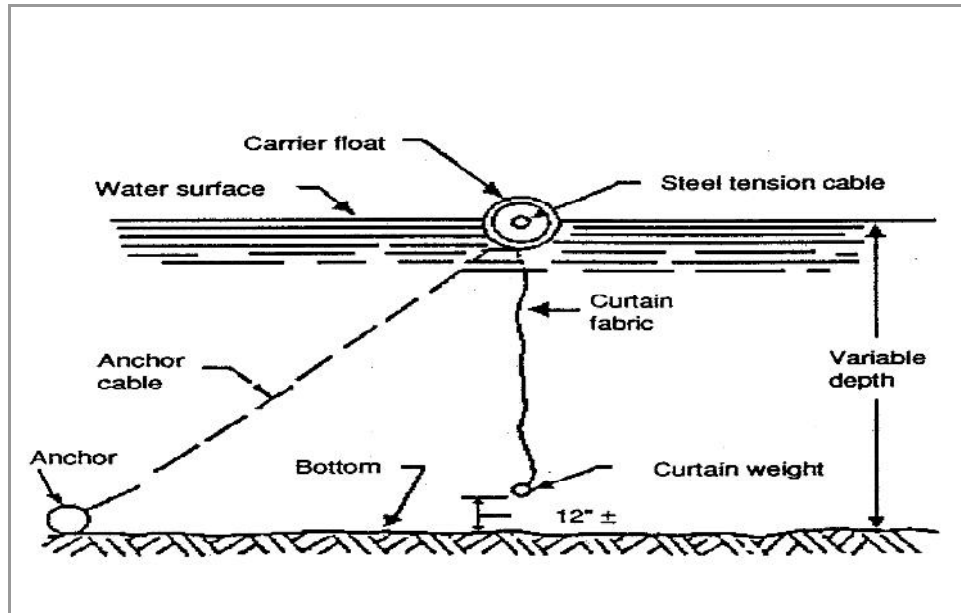
**DESCRIPTION:**

A flotation silt curtain is a silt barrier for use within a lake or pond. The flotation silt curtain consists of a filter fabric curtain weighted at the bottom and attached to a flotation device at the top. This structure is used to isolate an active construction area within a lake or pond to prevent silt-laden water from migrating out of the construction zone.

APPLICATIONS:

Where construction is conducted within a lake or pond area.

INSTALLATION/APPLICATION CRITERIA:

- ◆ The curtain should be constructed of a nylon fabric with a minimum tensile strength of 300 pounds per inch of fabric.
- ◆ The top of the curtain should have a flotation carrier consisting of a floating plastic tube (6-inch minimum diameter) filled with marine quality polyethylene foam. The flotation carrier should also have a 5/16" diameter coated steel cable in it to carry loads imposed upon the curtain.
- ◆ The bottom edge should be weighted by cable or chain with a minimum weight of 1.1 pounds per foot.
- ◆ One 24-pound anchor should be used per 100 feet of curtain.
- ◆ Where the curtain is made up of sections, the sections should be joined so that silt cannot permeate through the connection.

LIMITATIONS:

Not recommended in very shallow water bodies.

MAINTENANCE:

The silt curtain should be maintained until the construction area is stabilized and turbidity is reduced to acceptable levels.

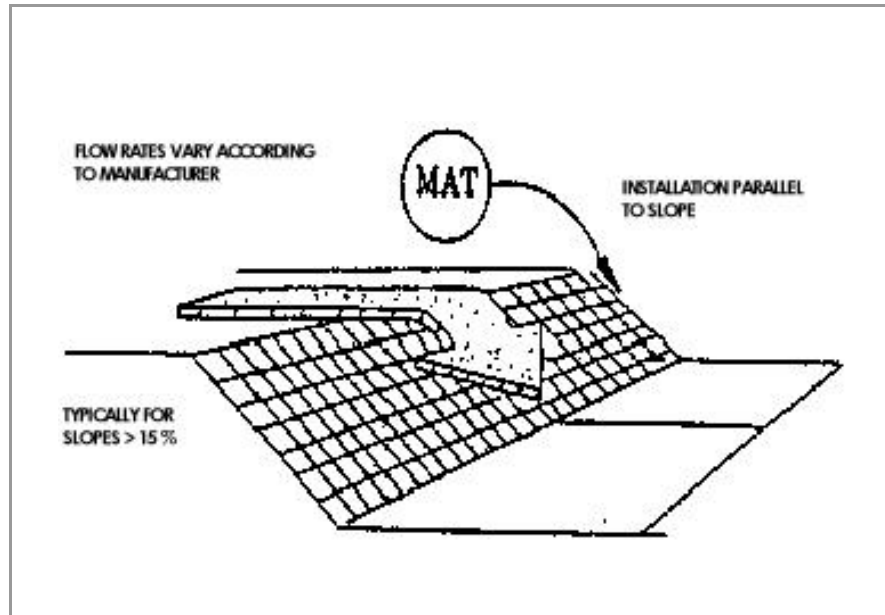
**DESCRIPTION:**

Mattings made of natural or synthetic material which are used to temporarily or permanently stabilize soil.

APPLICATION:

- ◆ Typically suited for post-construction site stabilization, but may be used for temporary stabilization of highly erosive soils.
- ◆ Channels and streams.
- ◆ Steep slopes.

INSTALLATION/APPLICATION CRITERIA:

- ◆ Mattings may be applied to disturbed soils and where existing vegetation has been removed.
- ◆ The following organic matting materials provide temporary protection until permanent vegetation is established, or when seasonal circumstances dictate the need for temporary stabilization until weather or construction delays are resolved: Jute mattings and straw mattings.
- ◆ The following synthetic mattings may be used for either temporary or post-construction stabilization, both with and without vegetation: excelsior matting, glass fiber matting, mulch matting.
- ◆ Staples are needed to anchor the matting.

LIMITATIONS:

- ◆ Mattings are more costly than other BMP practices, limiting their use to areas where other BMPs are ineffective (e.g., channels, steep slopes).
- ◆ May delay seed germination, due to reduction in soil temperature.
- ◆ Installation requires experienced contractor to ensure soil stabilization and erosion protection.

MAINTENANCE:

- ◆ Inspect monthly and after significant rainfall.
- ◆ Re-anchor loosened matting and replace missing matting and staples as required.

**DESCRIPTION:**

Prevent or reduce the discharge of pollutants to stormwater from hazardous waste through proper material use, waste disposal, and training of employees and subcontractors.

APPLICATION:

Many of the chemicals used on-site can be hazardous materials which become hazardous waste upon disposal. These wastes may include:

- ◆ Paints and solvents;
- ◆ Petroleum products such as oils, fuels, and grease;
- ◆ Herbicides and pesticides;
- ◆ Acids for cleaning masonry; and
- ◆ Concrete curing compounds.

In addition, sites with existing structures may contain wastes which must be disposed of in accordance with Federal, State, and local regulations, including:

- ◆ Sandblasting grit mixed with lead, cadmium, or chromium-based paints;
- ◆ Asbestos; and
- ◆ PCBs.

INSTALLATION/APPLICATION CRITERIA:

The following steps will help reduce storm water pollution from hazardous wastes:

- ◆ Use all of the product before disposing of the container.
- ◆ Do not remove the original product label, it contains important safety and disposal information.
- ◆ Do not over-apply herbicides and pesticides. Prepare only the amount needed. Follow the recommended usage instructions. Over-application is expensive and environmentally harmful. Apply surface dressings in several smaller applications, as opposed to one large application, to allow time for infiltration and to avoid excess material being carried off-site by runoff. Do not apply these chemicals just before it rains. People applying pesticides must be certified in accordance with Federal and State regulations.

LIMITATIONS:

Hazardous waste that cannot be reused or recycled must be disposed of by a licensed hazardous waste hauler.

MAINTENANCE:

- ◆ Inspect hazardous waste receptacles and area regularly.
- ◆ Arrange for regular hazardous waste collection.

**DESCRIPTION:**

A combination of wood fiber mulch, processed grass, or hay or straw mulch and a tacking agent. It is made into a slurry, then applied to bare slopes or other bare areas to provide temporary stabilization.

APPLICATIONS:

- ◆ Small roadside slopes.
- ◆ Large, relatively flat areas.

Installation/Application Criteria:

- ◆ Legume seeds should be pellet inoculated with the appropriate bacteria.
- ◆ The seed should not remain in the hydromulcher tank for more than 30 minutes.
- ◆ Wood fiber may be dyed to aid in uniform application.
- ◆ Slurry should be uniformly applied until an adequate coverage is achieved.
- ◆ The applicator should not be directed at one location for a long period of time; erosion will occur.

LIMITATIONS:

- ◆ Will lose effectiveness after 1 year.
- ◆ Can use only on physically stable slopes (at natural angle of repose, or less).

MAINTENANCE:

- ◆ Periodically inspect for damage caused by wind, water, or human disturbance.
- ◆ Promptly repair damaged areas.

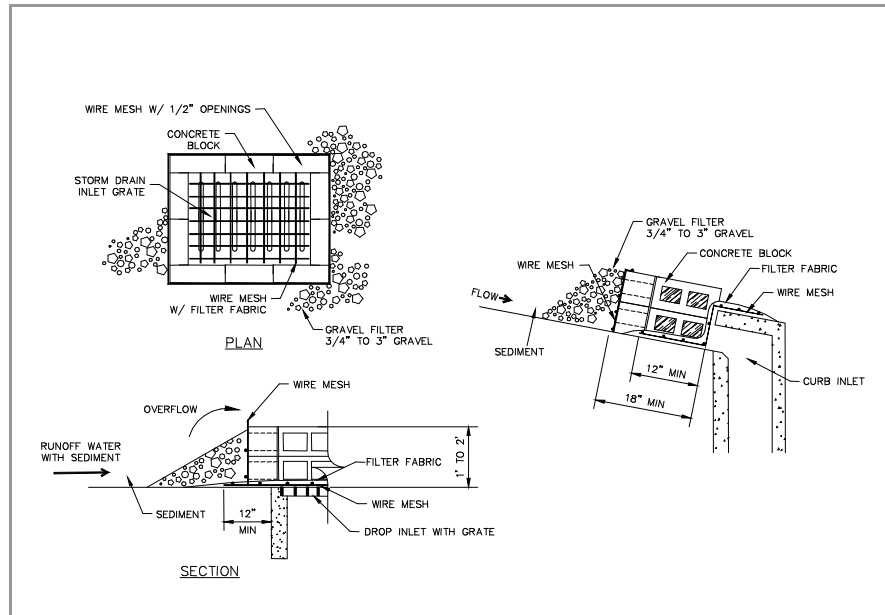

DESCRIPTION:

Concrete block and gravel filter placed over inlet to storm drain system.

APPLICATION:

Construct at inlets in paved or unpaved areas where upgradient area is to be disturbed by construction activities.

INSTALLATION/APPLICATION CRITERIA:

- ◆ Place wire mesh (with 1/2 inch openings) over the inlet grate extending one foot past the grate in all directions.
- ◆ Place concrete blocks around the inlet with openings facing outward. Stack blocks to minimum height of 12-inches and maximum height of 24-inches.
- ◆ Place wire mesh around outside of blocks.
- ◆ Place gravel (3/4" to 3") around blocks.

LIMITATIONS:

- ◆ Recommended for maximum drainage area of one acre.
- ◆ Excess flows may bypass the inlet requiring down gradient controls.
- ◆ Ponding will occur at inlet.

MAINTENANCE:

- ◆ Inspect inlet protection after every large storm event and at a minimum of once monthly.
- ◆ Remove sediment accumulated when it reaches 4-inches in depth.
- ◆ Replace filter fabric and clean or replace gravel if clogging is apparent.

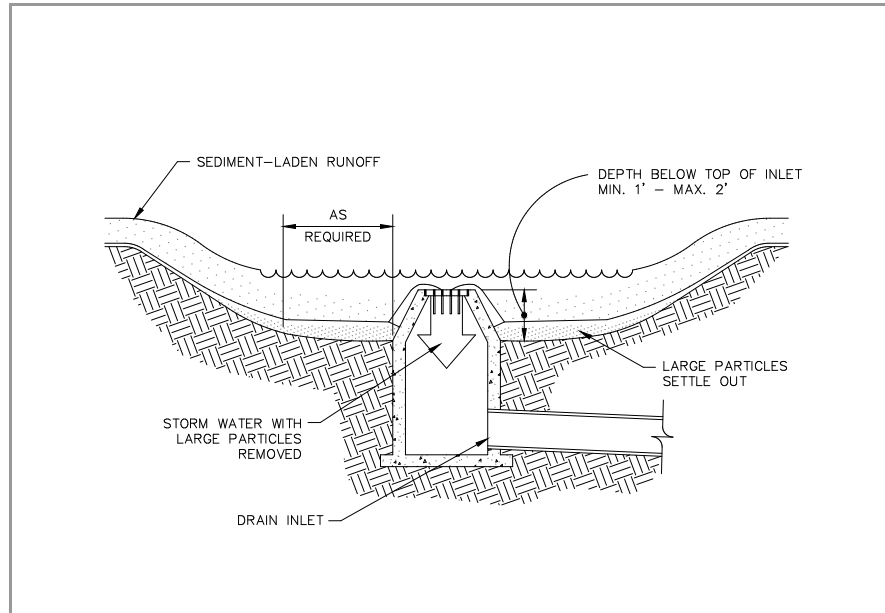
**DESCRIPTION:**

An area excavated around a storm drain inlet to impound water below the inlet.

APPLICATION:

Construct at storm drainage inlets located downgradient of areas to be disturbed by construction (for inlets in paved areas see other information sheets for inlet protection).

INSTALLATION/APPLICATION CRITERIA:

- ◆ Provide upgradient sediment controls, such as silt fence during construction of inlet.
- ◆ When construction of inlet is complete, excavate adjacent area 1 to 2 feet lower than the grate elevation. Size of excavated area should be based on soil type and contributing acreage.

LIMITATIONS:

- ◆ Recommended maximum contributing drainage area of one acre.
- ◆ Limited to inlets located in open unpaved areas.
- ◆ Requires flat area adjacent to inlet.

MAINTENANCE:

- ◆ Inspect inlet protection following storm event and at a minimum of once monthly.
- ◆ Remove accumulated sediment when it reaches one half of the excavated sump below the grate.
- ◆ Repair side slopes as required.

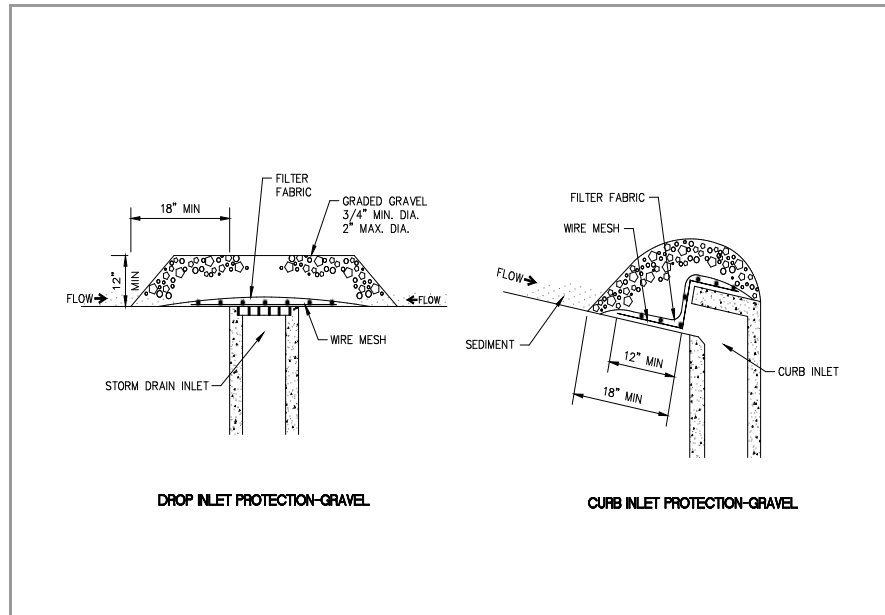
**DESCRIPTION:**

Placement of gravel filter over inlet to storm drain to filter storm water runoff.

APPLICATION:

Construct at inlets in paved or unpaved areas where upgradient area is to be disturbed by construction activities.

INSTALLATION/APPLICATION CRITERIA:

- ◆ Place wire mesh (with 1/2 inch openings) over the inlet grate extending one foot past the grate in all directions.
- ◆ Place filter fabric over the mesh. Filter fabric should be selected based on soil type.
- ◆ Place graded gravel, to a minimum depth of 12-inches, over the filter fabric and extending 18-inches past the grate in all directions.

LIMITATIONS:

- ◆ Recommended for maximum drainage area of one acre.
- ◆ Excess flows may bypass the inlet requiring down gradient controls.
- ◆ Ponding will occur at inlet.

MAINTENANCE:

- ◆ Inspect inlet protection after every large storm event and at a minimum of once monthly.
- ◆ Remove sediment accumulated when it reaches 4-inches in depth.
- ◆ Replace filter fabric and clean or replace gravel if clogging is apparent.

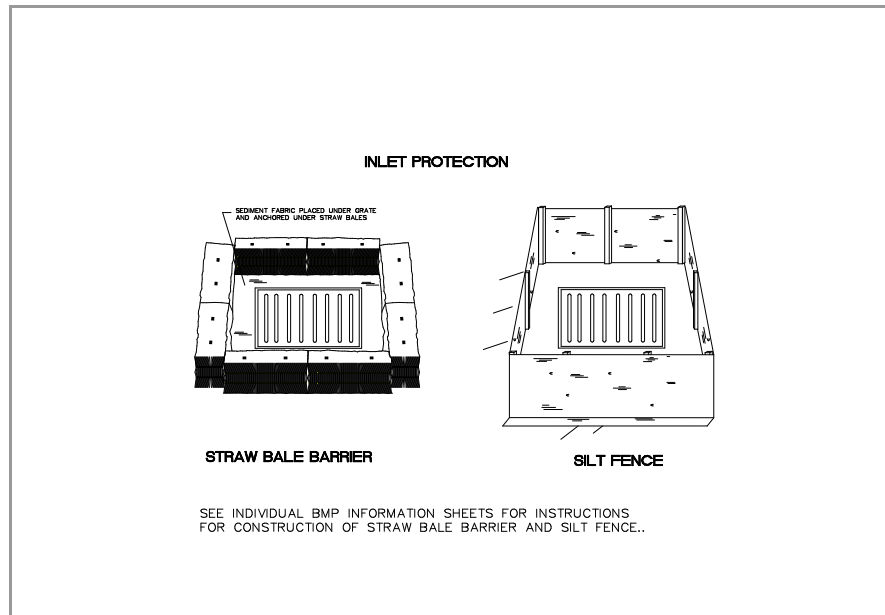
**DESCRIPTION:**

Sediment barrier erected around storm drain inlet.

APPLICATION:

Construct at storm drainage inlets located downgradient of areas to be disturbed by construction (for inlets in paved areas see other information sheets for inlet protection).

INSTALLATION/APPLICATION CRITERIA:

- ◆ Provide upgradient sediment controls, such as silt fence during construction of inlet.
- ◆ When construction of inlet is complete, erect straw bale barrier or silt fence surrounding perimeter of inlet. Follow instructions and guidelines on individual BMP information sheets for straw bale barrier and silt fence construction.

LIMITATIONS:

- ◆ Recommended maximum contributing drainage area of one acre.
- ◆ Limited to inlets located in open unpaved areas.
- ◆ Requires shallow slopes adjacent to inlet.

MAINTENANCE:

- ◆ Inspect inlet protection following storm event and at a minimum of once monthly.
- ◆ Remove accumulated sediment when it reaches 4-inches in depth.
- ◆ Repair or realign barrier/fence as needed.
- ◆ Look for bypassing or undercutting and recompact soil around barrier/fence as required.

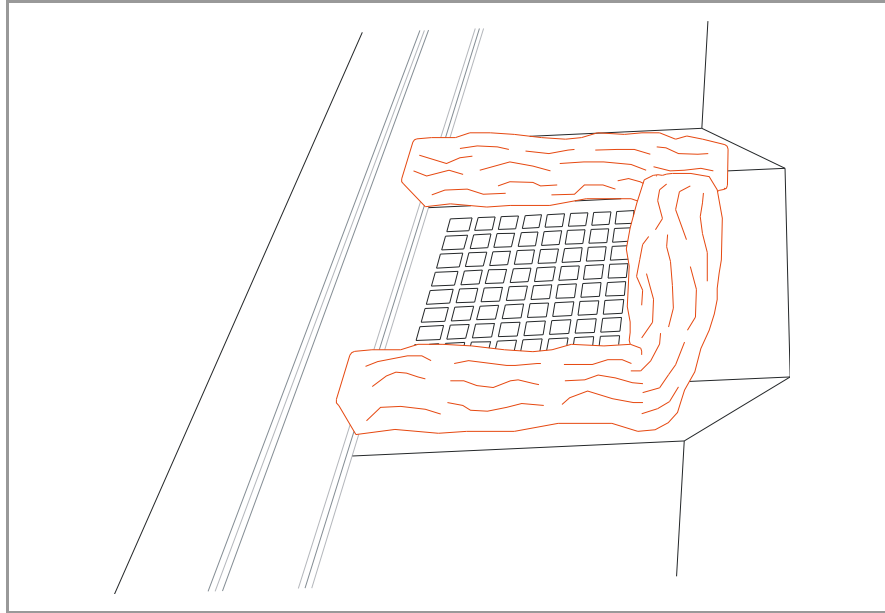
**DESCRIPTION:**

Sediment barrier erected around storm drain inlet.

APPLICATION:

Construct at storm drainage inlets located down-gradient of areas to be disturbed by construction.

INSTALLATION/APPLICATION CRITERIA:

- ◆ Provide up-gradient sediment controls, such as silt fence during construction of inlet
- ◆ When construction of curb and gutter and roadways is complete, install gravel filled wattles around perimeter of inlet

LIMITATIONS:

- ◆ Recommended maximum contributing drainage area of one acre
- ◆ Requires shallow slopes adjacent to inlet

MAINTENANCE:

- ◆ Inspect inlet protection following storm event and at a minimum of once every 14 days.
- ◆ Remove accumulated sediment when it reaches 4 inches in depth.
- ◆ Look for bypassing or undercutting and repair or realign as needed.

**DESCRIPTION:**

Stormwater control BMPs need regular inspections to ensure their effectiveness, and is required by the DWQ construction permit. Routine inspections are required on a bi-weekly basis; before and after anticipated storm events. Proper maintenance is crucial to compliance with the permit and to minimize erosion.

Routine inspections help to ensure the integrity and effectiveness of BMPs; inspections prior to a rain event ensure that BMPs are cleaned out and operating properly; inspections following a rain event serve to prepare the site for the next event. Maintenance should be conducted when problems are identified.

APPLICATIONS:

Inspections and maintenance is required by the DWQ permit at all sites. Maintenance needs are best determined by a self-inspection program.

INSTALLATION/APPLICATION CRITERIA:

The person responsible for the inspections should be trained in the design and operation of the BMPs.

LIMITATIONS:

Construction site operators should allocate adequate time and resources for BMP maintenance and repair.

**DESCRIPTION:**

Land grading involves reshaping the ground surface to planned grades as determined by an engineering survey, evaluation, and layout. Land grading provides more suitable topography for buildings, facilities, and other land uses and helps to control surface runoff, soil erosion, and sedimentation during and after construction.

APPLICATIONS:

Land grading is applicable to sites with uneven or steep topography or easily erodible soils, because it stabilizes slopes and decreases runoff velocity. Grading activities should maintain existing drainage patterns as much as possible.

INSTALLATION/APPLICATION CRITERIA:

Before grading activities begin, a construction site operator must make decisions regarding the steepness of cut-and-fill slopes and how the slopes will be: Protected from runoff, stabilized and maintained.

LIMITATIONS:

Improper grading practices that disrupt natural stormwater patterns might lead to poor drainage, high-runoff velocities, and increased peak flows during storm events. Clearing and grading the entire site without vegetated buffers promotes offsite transport of sediments and other pollutants. Design the grading plan with erosion and sediment control and stormwater management goals in mind; to ensure that the plan is implemented as intended, carefully supervise grading crews.

MAINTENANCE:

- ◆ Check all graded areas and supporting erosion and sediment control practices periodically, especially after heavy rainfalls.
- ◆ Promptly remove all sediment from diversions or other stormwater conveyances, and if washouts or breaks occur, repair them immediately.
- ◆ To prevent small-scale eroded areas from becoming significant gullies, maintain them promptly.

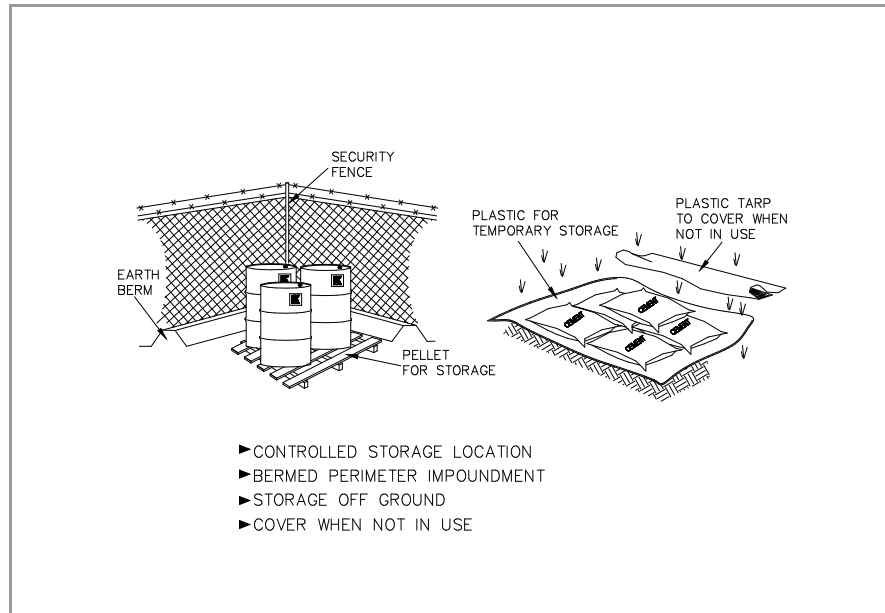
**DESCRIPTION:**

Controlled storage of on-site materials.

APPLICATION:

- ◆ Storage of hazardous, toxic, and all chemical substances.
- ◆ Any construction site with outside storage of materials.

INSTALLATION/APPLICATION CRITERIA:

- ◆ Designate a secured area with limited access as the storage location. Ensure no waterways or drainage paths are nearby.
- ◆ Construct compacted earthen berm (See Earth Berm Barrier Information Sheet), or similar perimeter containment around storage location for impoundment in the case of spills.
- ◆ Ensure all on-site personnel utilize designated storage area. Do not store excessive amounts of material that will not be utilized on site.
- ◆ For active use of materials away from the storage area ensure materials are not set directly on the ground and are covered when not in use. Protect storm drainage during use.

LIMITATIONS:

- ◆ Does not prevent contamination due to mishandling of products.
- ◆ Spill Prevention and Response Plan still required.
- ◆ Only effective if materials are actively stored in controlled location.

MAINTENANCE:

- ◆ Inspect daily and repair any damage to perimeter impoundment or security fencing.
- ◆ Check materials are being correctly stored (i.e. standing upright, in labeled containers, tightly capped) and that no materials are being stored away from the designated location.

**DESCRIPTION:**

Prevent or reduce the discharge of pollutants to storm water from material use by using alternative products, minimizing hazardous material use on-site, and training employees and subcontractors.

APPLICATION:

The following materials are commonly used on construction sites:

- ◆ Pesticides and herbicides, fertilizers, detergents, plaster and other products, petroleum products such as fuel, oil, and grease.
- ◆ Other hazardous chemicals such as acids, lime, glues, paints, solvents, and curing compounds.

INSTALLATION/APPLICATION CRITERIA:

- ◆ Use less hazardous, alternative materials as much as possible.
- ◆ Minimize use of hazardous materials on-site.
- ◆ Use only materials where and when needed to complete the construction activity.
- ◆ Follow manufacturer's instructions regarding uses, protective equipment, ventilation, flammability, and mixing of chemicals.
- ◆ Personnel who use pesticides should be trained in their use.
- ◆ Do not over apply fertilizers, herbicides, and pesticides. Prepare only the amount needed.
- ◆ Unless on steep slopes, till fertilizers in to the soil rather than hydroseeding.
- ◆ Do not apply these chemicals just before it rains.

LIMITATIONS:

Alternative materials may not be available, suitable, or effective in every case.

MAINTENANCE:

Maintenance of this best management practice is minimal.

DESCRIPTION:

Placement of material such as straw, grass, woodchips, woodfibers or fabricated matting over open area.

APPLICATION:

- ◆ Any exposed area to remain untouched longer than 14 days and that will be exposed less than 60 days (seed areas to be exposed in excess of 60 days).
- ◆ Areas that have been seeded.
- ◆ Stockpiled soil material.

Material	Application	Depth	Comments
<u>Gravel:</u> Washed 1/4" to 1-1/2"	9 cy/1000 sf	3 inches	Good for traffic areas Good for short slopes
<u>Straw:</u> Air-dried, free of seeds and coarse material	2-3 bales /1000 sf	2 inches min.	Subject to wind blowing Lack down or keep moist
<u>Wood Fiber Cellulose:</u> Free from growth inhibitors; dyed green	35 lb/1000 sf	1 inch	For critical areas, double application rate; Limit to slopes < 3% and < 150 feet

INSTALLATION/APPLICATION CRITERIA:

- ◆ Roughen area to receive mulch to create depressions that mulch material can settle into.
- ◆ Apply mulch to required thickness and anchor as necessary.
- ◆ Ensure material used is weed free and does not contain any constituents that will inhibit plant growth.

LIMITATIONS:

- ◆ Anchoring may be required to prevent migration of mulch material.
- ◆ Downgradient control may be required to prevent mulch material being transported to storm water system.

MAINTENANCE:

- ◆ Inspect mulched areas after every rainfall event and at a minimum of monthly.
- ◆ Replace mulch on any bare areas and re-anchor as necessary.
- ◆ Clean and replace downgradient controls as necessary.

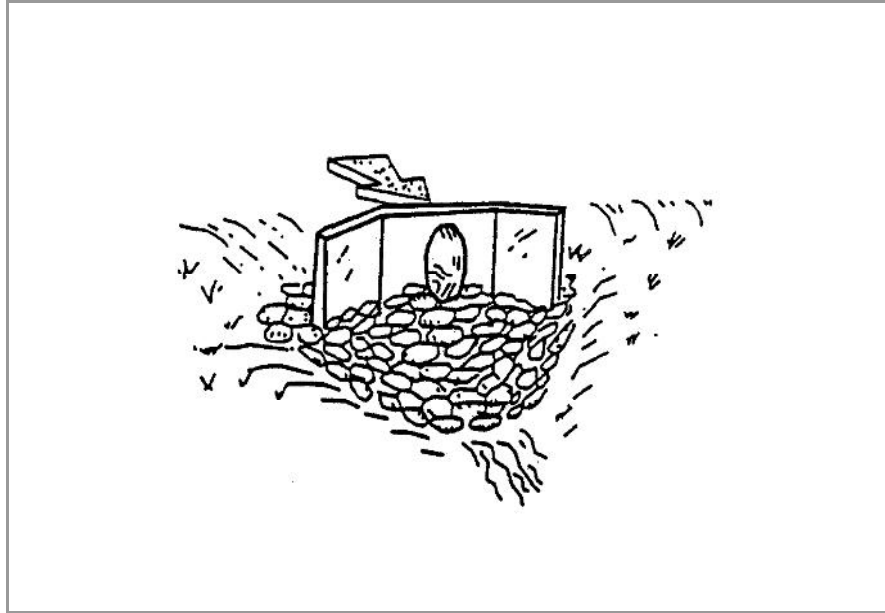
**DESCRIPTION:**

A rock outlet protection is a physical device composed of rock, grouted riprap, or concrete rubble which is placed at the outlet of a pipe to prevent scour of the soil caused by high pipe flow velocities, and to absorb flow energy to produce non-erosive velocities.

APPLICATIONS:

- ◆ Wherever discharge velocities and energies at the outlets of culverts, conduits, or channels are sufficient to erode the next downstream reach.
- ◆ Rock outlet protection is best suited for temporary use during construction because it is usually less expensive and easier to install than concrete aprons or energy dissipators.
- ◆ A sediment trap below the pipe outlet is recommended if runoff is sediment laden.
- ◆ Permanent rock riprap protection should be designed and sized by the engineer as part of the culvert, conduit or channel design.
- ◆ Grouted riprap should be avoided in areas of freeze and thaw because the grout will break up.

INSTALLATION/APPLICATION CRITERIA:

Rock outlet protection is effective when the rock is sized and placed properly. When this is accomplished, rock outlets do much to limit erosion at pipe outlets. Rock size should be increased for high velocity flows. Best results are obtained when sound, durable, angular rock is used.

LIMITATIONS:

- ◆ Large storms often wash away the rock outlet protection and leave the area susceptible to erosion.
- ◆ Sediment captured by the rock outlet protection may be difficult to remove without removing the rock.
- ◆ Outlet protection may negatively impact the channel habitat.

MAINTENANCE:

- ◆ Inspect after each significant rain for erosion and/or disruption of the rock, and repair immediately.
- ◆ Grouted or wire-tied rock riprap can minimize maintenance requirements.

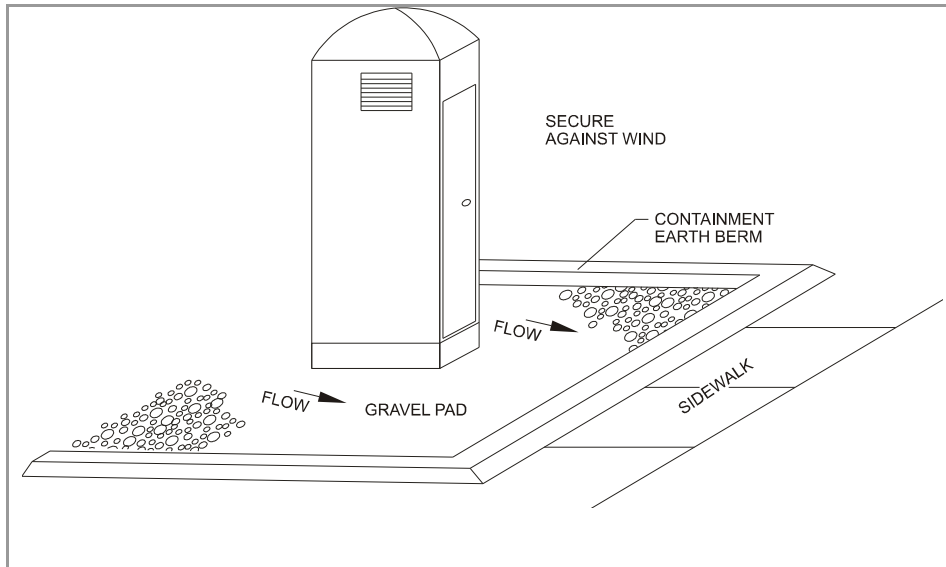
**DESCRIPTION:**

Temporary on-site sanitary facilities for construction personnel.

APPLICATION:

All sites with no permanent sanitary facilities or where permanent facility is too far from activities.

INSTALLATION/APPLICATION CRITERIA:

- ◆ Locate portable toilets in convenient locations throughout the site.
- ◆ Prepare level, gravel surface and provide clear access to the toilets for servicing and for on-site personnel.
- ◆ Construct earth berm perimeter (6" tall by 6" wide), control for spill/protection leak.

LIMITATIONS:

- ◆ No limitations.

MAINTENANCE:

- ◆ Portable toilets should be maintained in good working order by licensed service with daily observation for leak detection.
- ◆ Regular waste collection should be arranged with licensed service.
- ◆ All waste should be deposited in sanitary sewer system for treatment with appropriate agency approval.

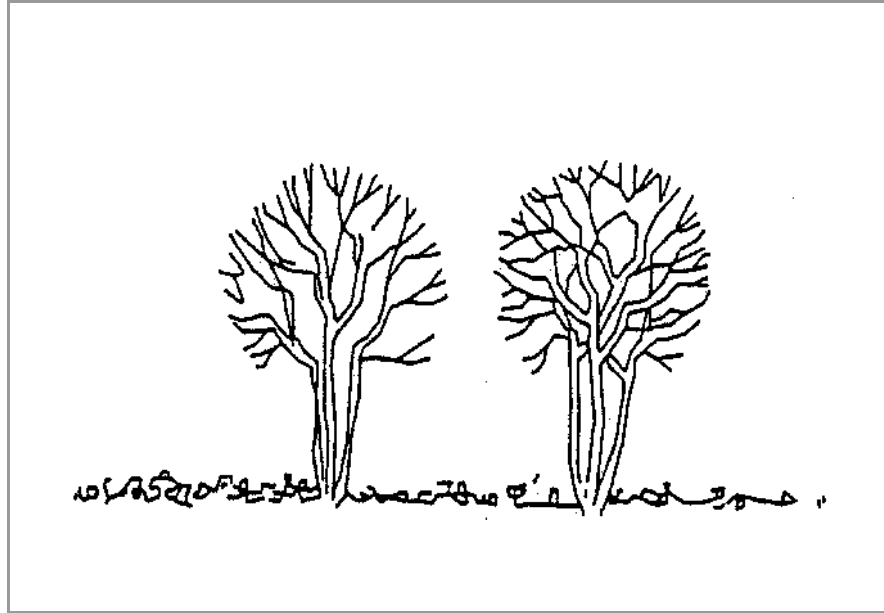
**DESCRIPTION:**

Carefully planned preservation of existing vegetation minimizes the potential of removing or injuring existing trees, vines, shrubs and/or grasses that serve as erosion controls.

APPLICATIONS:

This technique is applicable to all types of sites. Areas where preserving vegetation can be particularly beneficial are floodplains, wetlands, stream banks, steep slopes, and other areas where erosion controls would be difficult to establish, install, or maintain.

INSTALLATION/APPLICATION CRITERIA:

- ◆ Clearly mark, flag or fence vegetation or areas where vegetation should be preserved.
- ◆ Prepare landscaping plans which include as much existing vegetation as possible and state proper care during and after construction.
- ◆ Define and protect with berms, fencing, signs, etc. a setback area from vegetation to be preserved.
- ◆ Propose landscaping plans which do not include plant species that compete with the existing vegetation.
- ◆ Do not locate construction traffic routes, spoil piles, etc. where significant adverse impact on existing vegetation may occur.

LIMITATIONS:

- ◆ Requires forward planning by the owner/developer, contractor and design staff.
- ◆ For sites with diverse topography, it is often difficult and expensive to save existing trees while grading the site satisfactorily for the planned development.
- ◆ May not be cost effective with high land costs.

MAINTENANCE:

- ◆ Inspection and maintenance requirements for protection of vegetation are low.
- ◆ Maintenance of native trees or vegetation should conform to landscape plan specifications.

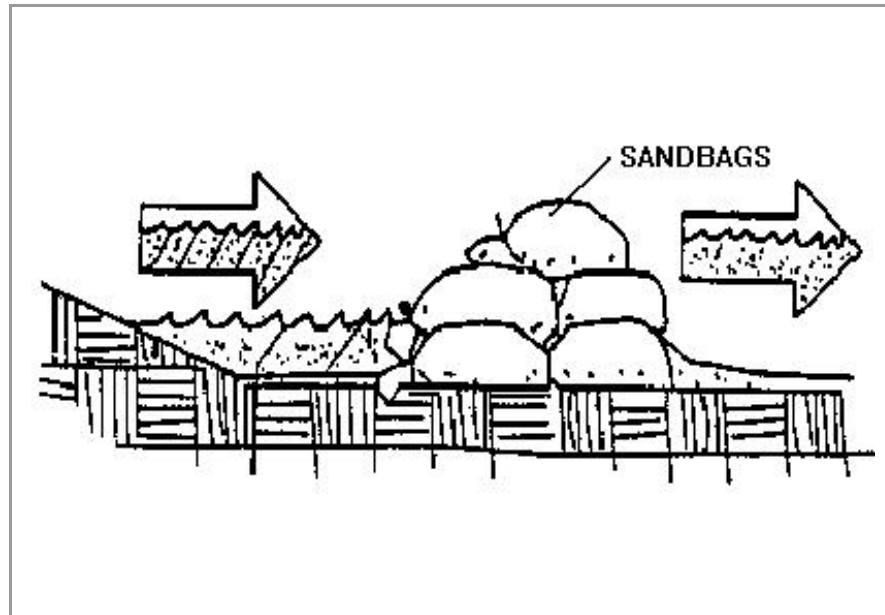
**DESCRIPTION:**

Stacking sandbags along a level contour creates a barrier which detains sediment-laden water, ponding water upstream of the barrier and promoting sedimentation.

APPLICATION:

- ◆ Along the perimeter of the site.
- ◆ May be used in drainage areas up to 5 acres.
- ◆ Along streams and channels
- ◆ Across swales with small catchments.
- ◆ Around temporary spoil areas.
- ◆ Below the toe of a cleared slope.

INSTALLATION/APPLICATION CRITERIA:

- ◆ Install along a level contour.
- ◆ Base of sandbag barrier should be at least 48 inches wide.
- ◆ Height of sandbag barrier should be at least 18 inches high.
- ◆ 4 inch PVC pipe may be installed between the top layer of sand bags to drain large flood flows.
- ◆ Provide area behind barrier for runoff to pond and sediment to settle.
- ◆ Place below the toe of a slope.

LIMITATIONS:

- ◆ Sandbags are more expensive than other barriers, but also more durable.
- ◆ Burlap should not be used.

MAINTENANCE:

- ◆ Inspect after each rain.
- ◆ Reshape or replace damaged sandbags immediately.
- ◆ Replace sediment when it reaches six inches in depth.

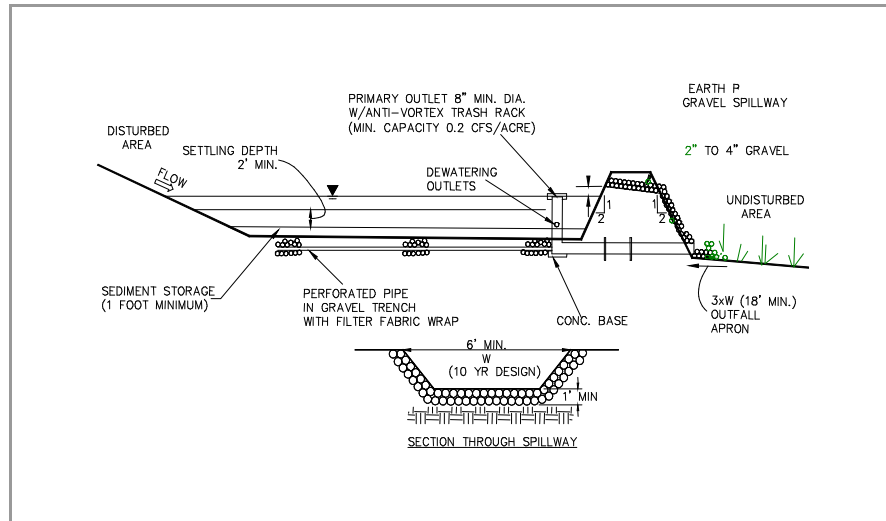

DESCRIPTION:

A pond created by excavation or construction of an embankment, and designed to retain or detain runoff sufficiently to allow excessive sediment to settle.

APPLICATION:

- ◆ At the outlet of all disturbed watersheds 10 acres or larger.
- ◆ At the outlet of smaller disturbed watersheds, as necessary.
- ◆ Where post construction detention basins will be located.

INSTALLATION/APPLICATION CRITERIA:

- ◆ Design basin for site specific location, maintain effective flow length 2 times width.
- ◆ Excavate basin or construct compacted berm containment, ensure no downgradient hazard if failure should occur. (Provide minimum of 67 cy. per acre of drainage area).
- ◆ Construct dewatering and outfall structure and emergency spillway with apron.

LIMITATIONS:

- ◆ Should be sized based on anticipated runoff, sediment loading and drainage area size.
- ◆ May require silt fence at outlet for entrapment of very fine silts and clays.
- ◆ May require safety fencing to prevent public access.
- ◆ Height restrictions for embankment may be regulated.

MAINTENANCE:

- ◆ Inspect after each rainfall event and at a minimum of monthly.
- ◆ Repair any damage to berm, spillway or sidewalls.
- ◆ Remove accumulated sediment as it reaches 2/3 height of available storage.
- ◆ Check outlet for sedimentation/erosion of downgradient area and remediate as necessary. Install silt fence if sedimentation apparent.

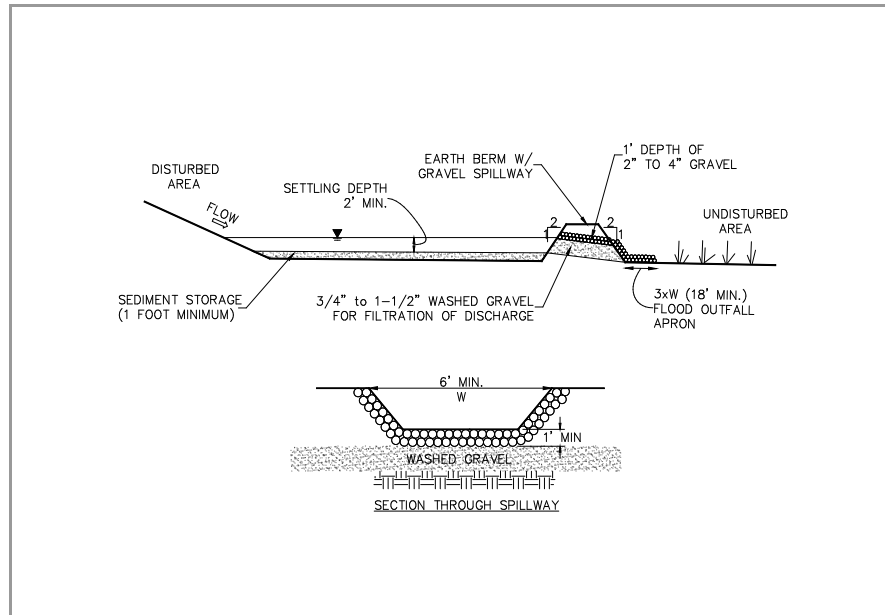

DESCRIPTION:

A sediment trap is a small excavated or bermed area where runoff from small drainage areas is detained and sediment can settle.

APPLICATION:

- ◆ Temporary control for runoff from disturbed areas of less than 3 acres.
- ◆ Temporary control for discharge from diversion dike, surface benching, or other temporary drainage measures.

INSTALLATION/APPLICATION CRITERIA:

- ◆ Design basin for site specific location.
- ◆ Excavate basin or construct compacted berm containment.
- ◆ Construct outfall spillway with apron.
- ◆ Provide downstream silt fence if necessary.

LIMITATIONS:

- ◆ Should be sized based on anticipated runoff, sediment loading and drainage area size.
- ◆ May require silt fence at outlet for entrapment of very fine silts and clays.

MAINTENANCE:

- ◆ Inspect after each rainfall event and at a minimum of monthly.
- ◆ Repair any damage to berm, spillway or sidewalls.
- ◆ Remove accumulated sediment as it reaches 2/3 height of available storage.
- ◆ Check outlet for sedimentation/erosion of downgradient area and remediate as necessary. Install silt fence if sedimentation apparent.

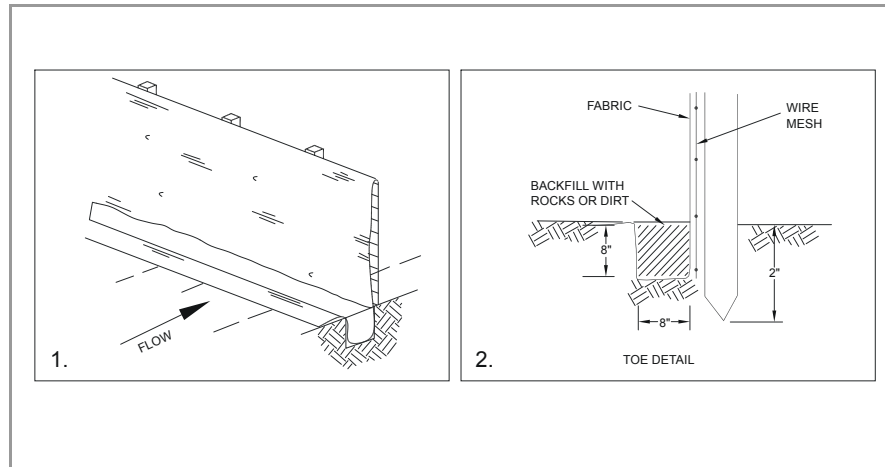

DESCRIPTION:

A temporary sediment barrier consisting of entrenched filter fabric stretched across and secured to supporting posts.

Application:

- ◆ Perimeter control: place barrier at down-gradient limits of disturbance
- ◆ Sediment barrier: place barrier at toe of slope or soil stockpile
- ◆ Protection of existing waterways: place barrier at top of stream bank
- ◆ Inlet protection: place fence surrounding catchbasins

INSTALLATION/APPLICATION CRITERIA:

- ◆ Place posts 6 feet apart on center along contour (or use preassembled unit) and drive 2 feet minimum into ground. Excavate an anchor trench immediately up-gradient of posts.
- ◆ Secure wire mesh (14 gage min. with 6-inch openings) to upslope side of posts. Attach with heavy duty 1 inch long wire staples, tie wires or hog rings.
- ◆ Cut fabric to required width, unroll along length of barrier and drape over barrier. Secure fabric to mesh with twine, staples, or similar, with trailing edge extending into anchor trench.
- ◆ Backfill trench over filter fabric to anchor.

LIMITATIONS:

- ◆ Recommended maximum drainage area of 0.5 acre per 100 feet of fence
- ◆ Recommended maximum up-gradient slope length of 150 feet
- ◆ Recommended maximum uphill grade of 2:1 (50%)
- ◆ Recommended maximum flow rate of 0.5 cfs
- ◆ Ponding should not be allowed behind fence

MAINTENANCE:

- ◆ Inspect immediately after any rainfall and at least daily during prolonged rainfall.
- ◆ Look for runoff bypassing ends of barriers or undercutting barriers.
- ◆ Repair or replace damaged areas of the barrier and remove accumulated sediment.
- ◆ Reanchor fence as necessary to prevent shortcutting.
- ◆ Remove accumulated sediment when it reaches 1/2 the height of the fence.

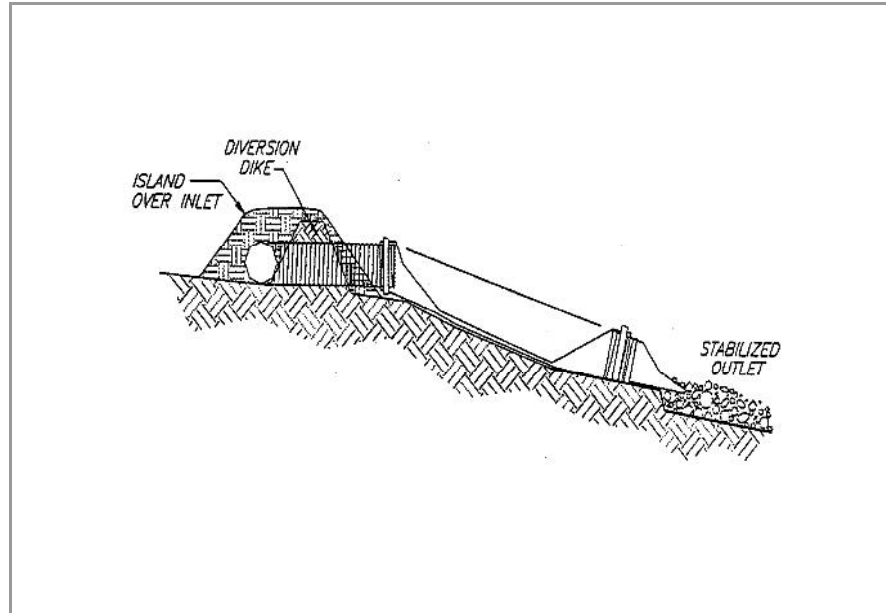
**DESCRIPTION:**

A temporary pipe or lined channel that drains the top of a slope to a stable discharge point at the bottom of a slope without causing erosion.

APPLICATIONS:

- ◆ Where concentrated flow of surface runoff must be conveyed down a slope in order to prevent erosion.
- ◆ Drainage for top slope diversion dikes or swales.
- ◆ Emergency spillway for a sediment basin.
- ◆ Drainage for top of cut/fill slopes where water can accumulate.

INSTALLATION/APPLICATION CRITERIA:

- ◆ Secure inlet and surround with dikes to prevent gully erosion, and anchor pipe to slope.
- ◆ Size to convey at least the peak of a 10-year, storm event.
- ◆ Stabilize outlet. (See Outlet Protection BMP).

LIMITATIONS:

- ◆ Maximum drainage area per slope drain is 5 acres.
- ◆ Clogged slope drains will force water around the pipe and cause slope erosion.
- ◆ Dissipation of high flow velocities at the pipe outlet is required to avoid downstream erosion.
- ◆ Failure can result in flooding and severe erosion.

MAINTENANCE:

- ◆ Structure must be inspected weekly and after storms.
- ◆ Inlet must be free of undercutting and no water should circumvent the entry.
- ◆ Outlet should not produce erosion; velocity dissipators must be maintained.
- ◆ Pipe anchors must be checked to ensure that the pipe remains anchored to the slope.

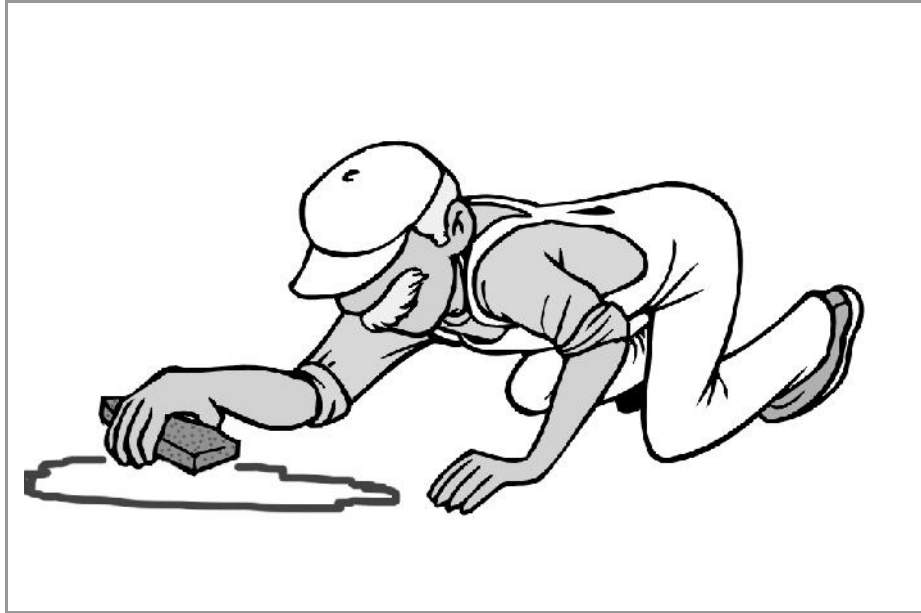
**DESCRIPTION:**

Practices to clean-up leakage/spillage of on-site materials that may be harmful to receiving waters.

APPLICATION:

All sites

GENERAL:

- ◆ Store controlled materials within a storage area.
- ◆ Educate personnel on prevention and clean-up techniques.
- ◆ Designate an Emergency Coordinator responsible for employing preventative practices and for providing spill response.
- ◆ Maintain a supply of clean-up equipment on-site and post a list of local response agencies with phone numbers.

METHODS:

- ◆ Clean-up spills/leaks immediately and remediate cause.
- ◆ Use as little water as possible. **NEVER HOSE DOWN OR BURY SPILL CONTAMINATED MATERIAL.**
- ◆ Use rags or absorbent material for clean-up. Excavate contaminated soils. Dispose of clean-up material and soil as hazardous waste.
- ◆ Document all spills with date, location, substance, volume, actions taken and other pertinent data.
- ◆ Contact the Salt Lake County Health Department (313-6700) for any spill of reportable quantity.

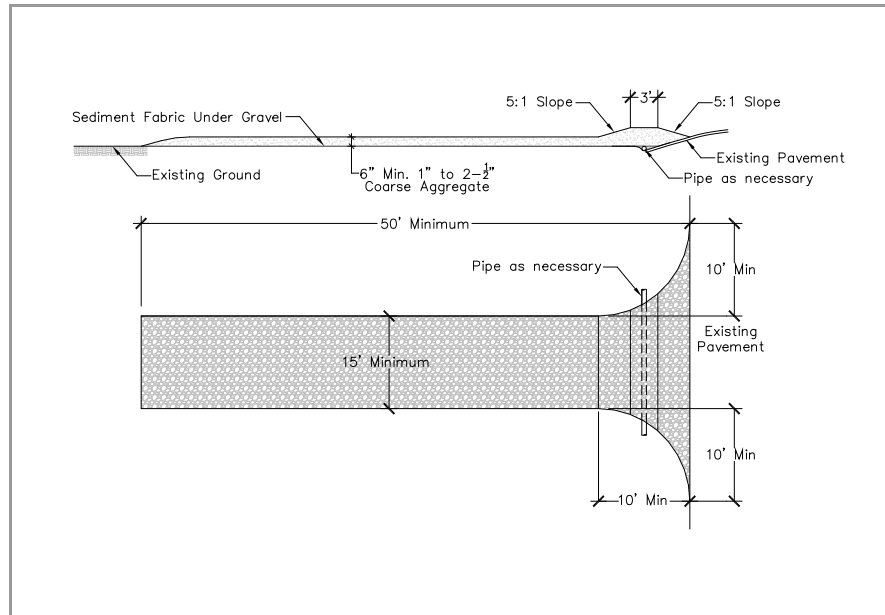
**DESCRIPTION:**

A stabilized pad of crushed stone located where construction traffic enters or leaves the site from or to paved surface.

APPLICATION:

At any point of ingress or egress at a construction site where adjacent traveled way is paved. Generally applies to sites over 2 acres unless special conditions exist.

INSTALLATION/APPLICATION CRITERIA:

- ◆ Clear and grub area and grade to provide maximum slope of 2%.
- ◆ Compact subgrade and place filter fabric if desired (recommended for entrances to remain for more than 3 months).
- ◆ Place coarse aggregate, 1 to 2-1/2 inches in size, to a minimum depth of 8 inches.

LIMITATIONS:

- ◆ Requires periodic top dressing with additional stones.
- ◆ Should be used in conjunction with street sweeping on adjacent public right-of-way.

MAINTENANCE:

- ◆ Inspect daily for loss of gravel or sediment buildup.
- ◆ Inspect adjacent roadway for sediment deposit and clean by sweeping or shoveling.
- ◆ Repair entrance and replace gravel as required to maintain control in good working condition.
- ◆ Expand stabilized area as required to accommodate traffic and prevent erosion at driveways.

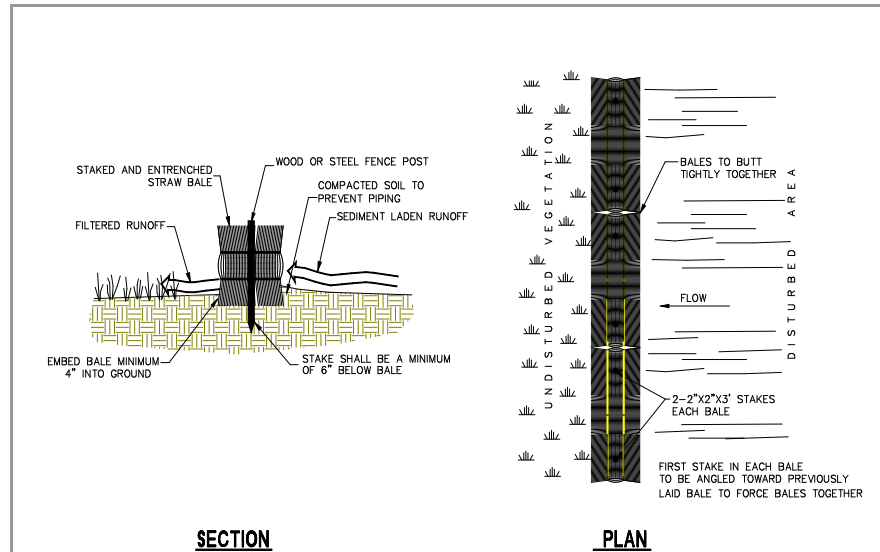

DESCRIPTION:

Temporary sediment barrier consisting of a row of entrenched and anchored straw bales.

APPLICATIONS:

- ◆ Perimeter control: place barrier at down-gradient limits of disturbance.
- ◆ Sediment barrier: place barrier at toe of slope or soil stockpile.
- ◆ Protection of existing waterways: place barrier at top of stream bank.
- ◆ Inlet protection.

INSTALLATION/APPLICATION CRITERIA:

- ◆ Excavate a 4-inch minimum deep trench along contour line, i.e. parallel to slope, removing all grass and other material that may allow underflow.
- ◆ Place bales in trench with ends tightly abutting, fill any gaps by wedging loose straw into openings.
- ◆ Anchor each bale with 2 stakes driven flush with the top of the bale.
- ◆ Backfill around bale and compact to prevent piping, backfill on uphill side to be built up 4-inches above ground at the barrier.

LIMITATIONS:

- ◆ Recommended maximum area of 0.5 acre per 100 feet of barrier
- ◆ Recommended maximum up-gradient slope length of 150 feet
- ◆ Recommended maximum uphill grade of 2:1 (50%)

MAINTENANCE:

- ◆ Inspect immediately after any rainfall and at least daily during prolonged rainfall.
- ◆ Look for runoff bypassing ends of barriers or undercutting barriers.
- ◆ Repair or replace damaged areas of the barrier and remove accumulated sediment.
- ◆ Realign bales as necessary to provide continuous barrier and fill gaps.
- ◆ Recompress soil around barrier as necessary to prevent piping.

**DESCRIPTION:**

Reduce the discharges of pollutants to stormwater from street surfaces by conducting street cleaning on a regular basis.

APPROACH:

- ◆ Prioritize cleaning to use the most sophisticated sweepers, at the highest frequency, and in areas with the highest pollutant loading.
- ◆ Restrict street parking prior to and during sweeping.
- ◆ Increase sweeping frequency just before the rainy season.
- ◆ Proper maintenance and operation of sweepers greatly increase their efficiency.
- ◆ Keep accurate operation logs to track programs.
- ◆ Sweepers effective at removing smaller particles (less than 10 microns) may generate dust that would lead to concerns over worker and public safety.
- ◆ Equipment selection can be key for this particular BMP. There are two types used, the mechanical broom sweepers (more effective at picking up large debris and cleaning wet streets), and the vacuum sweepers (more effective at removing fine particles and associated heavy metals). Many communities find it useful to have a compliment of both types in their fleet.

LIMITATIONS:

- ◆ Conventional sweepers are not able to remove oil and grease.
- ◆ Mechanical sweepers are not effective at removing finer sediments.
- ◆ Effectiveness may also be limited by street conditions, traffic congestion, presence of construction projects, climatic conditions and condition of curbs.

MAINTENANCE:

- ◆ Replace worn parts as necessary.
- ◆ Install main and gutter brooms of the appropriate weight.

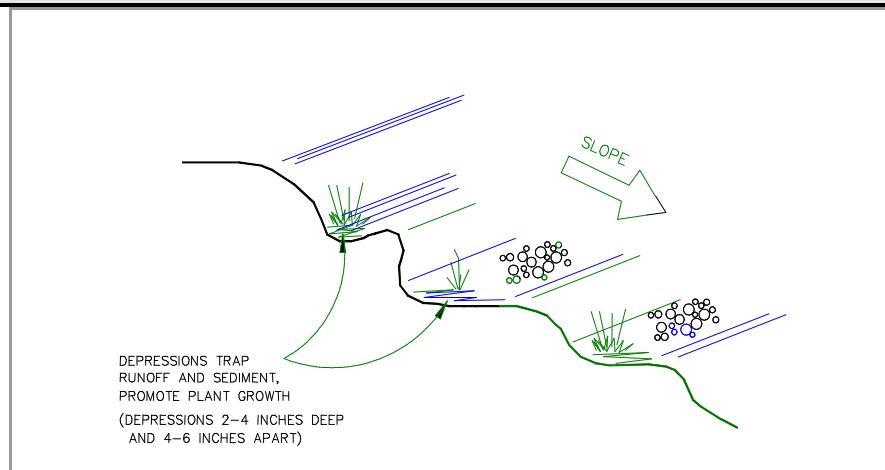
**DESCRIPTION:**

Rough preparation of working areas leaving depressions and uneven surface. Depressions should be done parallel to contours.

APPLICATION:

Surface roughening is appropriate for all construction that will not be receiving impervious cover within 14 days and that will be exposed less than 60 days (seed areas to be open in excess of 60 days).

INSTALLATION/APPLICATION CRITERIA:

- ◆ Surface should be left in rough condition during initial earthwork activity.
- ◆ Surfaces that have become smoothed or compacted due to equipment traffic should be roughened by use of disks, spring harrows, teeth on front end loader, or similar, operating along the contours of the slope. Tracking (by crawler tractor driving up and down slope) may also be used to provide depressions parallel to contours.
- ◆ Avoid compaction of soils during roughening as this inhibits plant growth and promotes storm water runoff. Limit tracked machinery to sandy soil.
- ◆ Seed or mulch areas to be exposed in excess of 60 days.
- ◆ Employ dust controls.

LIMITATIONS:

- ◆ Will not withstand heavy rainfall.
- ◆ Slopes steeper than 2:1 (50%) should be benched.

MAINTENANCE:

- ◆ Inspect following any storm event and at a minimum of weekly.
- ◆ If erosion in the form of rills (small waterways formed by runoff) is evident, perform machine roughening of area.
- ◆ For vegetated slopes reseed areas that are bare or have been reworked.

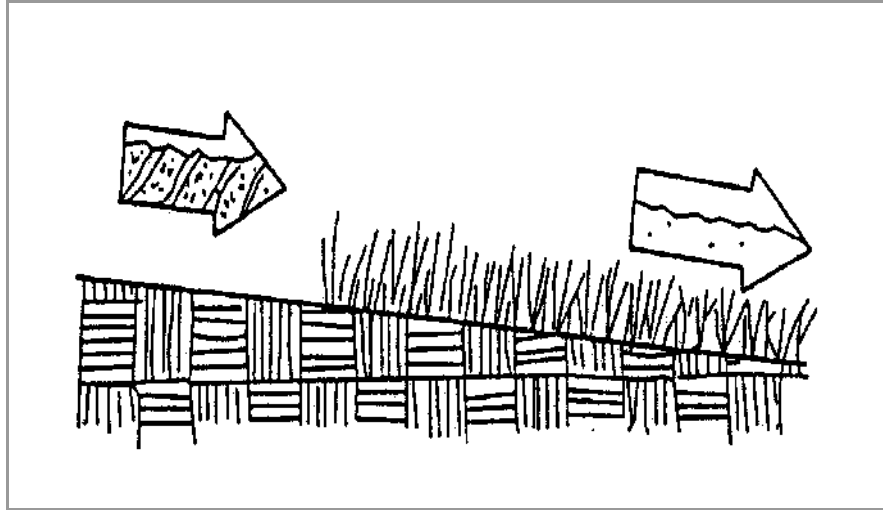
**DESCRIPTION:**

Seeding of grass and plantings of trees, shrubs, vines and ground covers provide long-term stabilization of soil. In some areas, with suitable climates, grasses can be planted for stabilization.

Temporary seeding - establishment of short term cover by application of rapidly germinating seed mix (alternatively hydro-seeding may be utilized).

Permanent seeding - establishment of final term cover by application of perennial seed mix (alternatively sod may be utilized).

APPLICATION:

- ◆ Appropriate for site stabilization both during construction and post-construction.
- ◆ Any graded/cleared areas where construction activities have ceased.
- ◆ Open space cut and fill areas.
- ◆ Steep slopes, spoil piles, vegetated swales, landscape corridors, stream banks.

INSTALLATION/APPLICATION CRITERIA:

Type of vegetation, site and seedbed preparation, planting time, fertilization and water requirements should be considered for each application. The recommended seed mix will be dependent on site specific information such as elevation, exposure, soils, water availability and topography. Appropriate ground preparation and fertilizer must be considered.

LIMITATIONS:

- ◆ Permanent and temporary vegetation may not be appropriate in dry periods without irrigation.
- ◆ Fertilizer requirements may have potential to create stormwater pollution.

MAINTENANCE:

- ◆ Shrubs and trees must be adequately watered and fertilized and if needed pruned.
- ◆ Grasses may need to be watered and mowed.
- ◆ Provide irrigation as required to establish growth and to maintain plant cover through duration of project.
- ◆ Reseed as necessary to provide 75% coverage
- ◆ Remediate any areas damaged by erosion or traffic.
- ◆ When 75% coverage is achieved inspect monthly for damage and remediate as necessary.

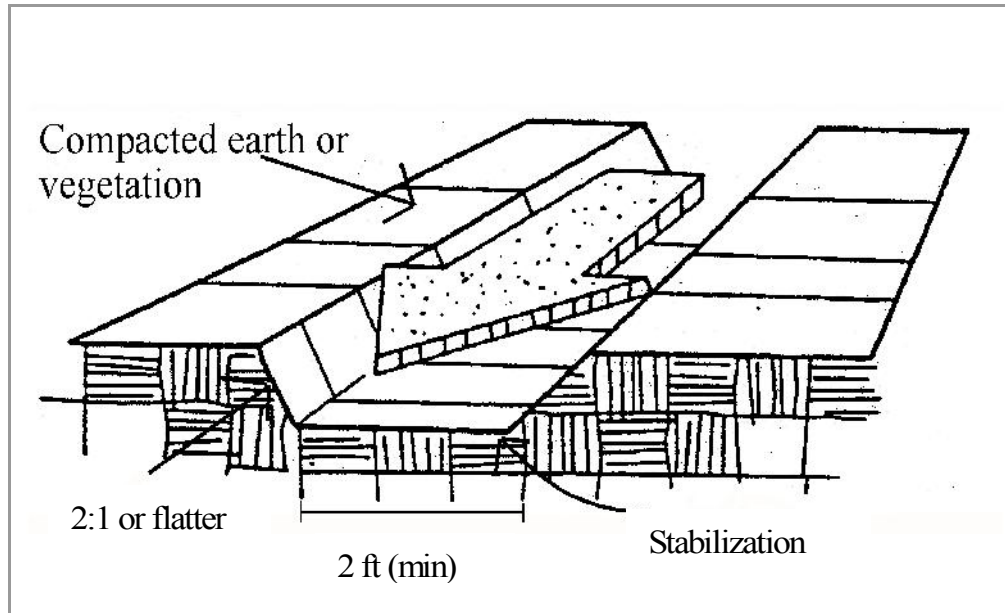
**DESCRIPTION:**

Temporary drains and swales are used to divert off-site runoff around the construction site, divert runoff from stabilized areas around disturbed areas, and direct runoff into sediment.

APPLICATIONS:

- ◆ Temporary drains and swales are appropriate for diverting any upslope runoff around unstabilized or disturbed areas of the construction site.
- ◆ Prevent slope failures. Prevent damage to adjacent property. Prevents erosion and transport of sediments into water ways. Increases the potential for infiltration. Diverts sediment-laden runoff into sediment basins or traps.

INSTALLATION/APPLICATION:

- ◆ Temporary drainage swales will effectively convey runoff and avoid erosion if built properly:
- ◆ Size temporary drainage swales using local drainage design criteria. A permanent drainage channel must be designed by a professional engineer (see the local drainage design criteria for proper design).
- ◆ At a minimum, the drain/swale should conform to predevelopment drainage patterns and capacities.
- ◆ Construct the drain/swale with an uninterrupted, positive grade to a stabilized outlet. Provide erosion protection or energy dissipation measures if the flow out of the drain or swale can reach an erosive velocity.

LIMITATIONS:

- ◆ Temporary drains and swales or any other diversion of runoff should not adversely impact upstream or downstream properties.
- ◆ Temporary drains and swales must conform to local floodplain management requirements.

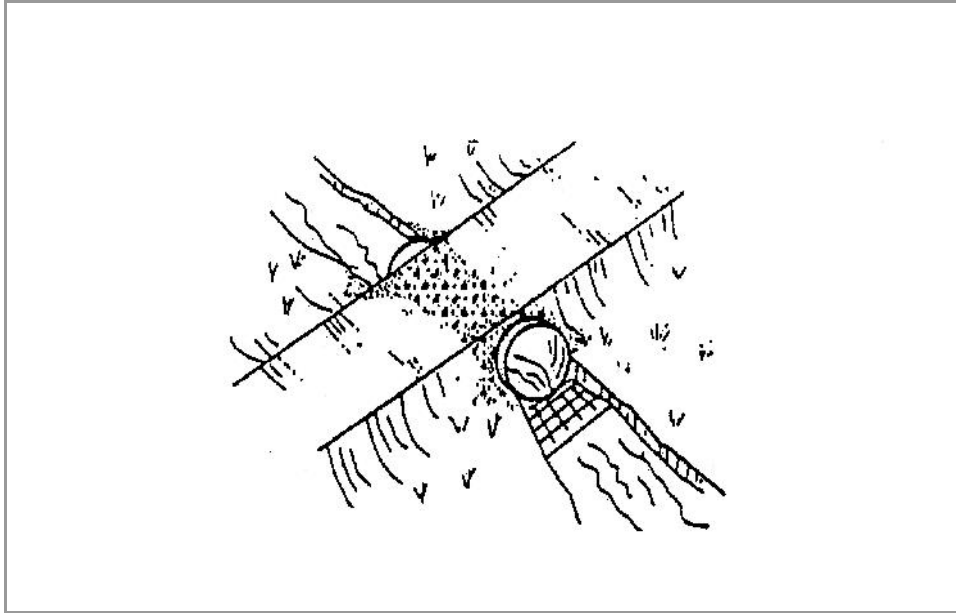
**DESCRIPTION:**

A temporary access stream crossing is a temporary culvert, ford or bridge placed across a waterway to provide access for construction purposes for a period of less than one year. Temporary access crossings are not intended to be used to maintain traffic for the general public.

APPLICATIONS:

Temporary stream crossings should be installed at all designated crossings of perennial and intermittent streams on the construction site, as well as for dry channels which may be significantly eroded by construction traffic.

INSTALLATION/APPLICATION:

Requires knowledge of stream flows and soil strength and should be designed under the direction of a Utah registered engineer with knowledge of both hydraulics and construction loading requirements for structures.

LIMITATIONS:

- ◆ May be an expensive for a temporary improvement.
- ◆ Requires other BMP's to minimize soil disturbance during installation and removal.
- ◆ Fords should only be used in dry weather.
- ◆ A Stream Alteration Permit may be required, contact the Utah Division of Water Rights before implementation.

MAINTENANCE:

- ◆ Inspect weekly and after each significant rainfall, including assessment of foundations.
- ◆ Periodically remove silt from crossings.
- ◆ Replace lost aggregated from inlets and outlets of culverts.

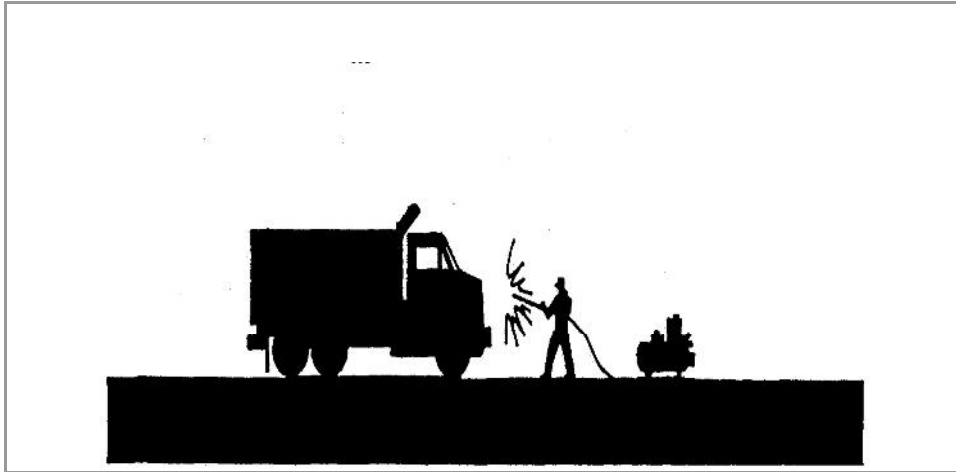

DESCRIPTION:

Prevent or reduce the discharge of pollutants to storm water from vehicle and equipment cleaning by washing in designated, contained areas only, eliminating discharges to the storm drain by infiltrating or recycling the wash water, and/or training employees and subcontractors.

INSTALLATION/APPLICATION:

- ◆ Use designated, bermed wash areas to prevent wash water contact with storm water, creeks, rivers, and other water bodies. The wash area can be sloped for wash water collection and subsequent infiltration into the ground.
- ◆ Use as little water as possible to avoid having to install erosion and sediment controls for the wash area. Use phosphate-free biodegradable soaps. Educate employees and subcontractors on pollution prevention measures. Do not permit steam cleaning on-site. Steam cleaning can generate significant pollutant concentrations.

LIMITATIONS:

- ◆ Even phosphate-free, biodegradable soaps have been shown to be toxic to fish before the soap degrades.
- ◆ Sending vehicles/equipment off-site should be done in conjunction with Stabilized Construction Entrance.

MAINTENANCE:

- ◆ Minimal, some berm repair may be necessary.

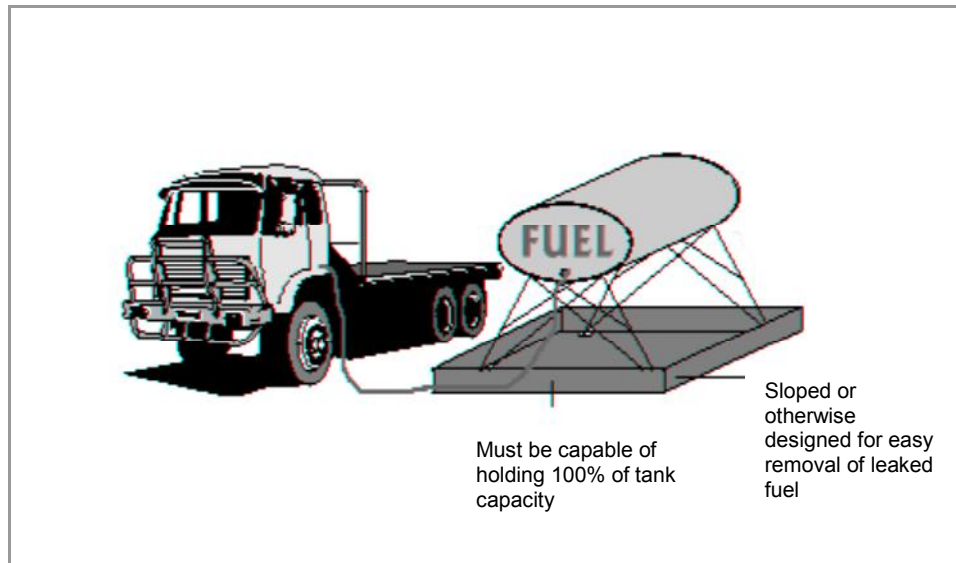
**DESCRIPTION:**

Prevent fuel spills and leaks, and reduce their impacts to storm water by using off-site facilities, fueling in designated areas only, enclosing or covering stored fuel, implementing spill controls, and training employees and subcontractors.

INSTALLATION/APPLICATION:

- ◆ Use off-site fueling stations as much as possible. Fueling vehicles and equipment outdoors or in areas where fuel may spill/leak onto paved surfaces or into drainage pathways can pollute storm water. If you fuel a large number of vehicles or pieces of equipment, consider using an off-site fueling station. These areas are better equipped to handle fuel and spills properly. Performing this work off-site can also be economical by eliminating the need for a separate fueling area at your site.
- ◆ If fueling must occur on-site, use designated areas, located away from drainage courses, to prevent the runoff of storm water and the runoff of spills. Discourage topping-off of fuel tanks.
- ◆ Always use secondary containment, such as a drain pan or drop cloth, when fueling to catch spills/leaks. Place a stockpile of spill cleanup materials where it will be readily accessible. Use adsorbent materials on small spills rather than hosing down or burying the spill. Remove the adsorbent materials promptly and dispose of properly.
- ◆ Carry out all Federal and State requirements regarding stationary above ground storage tanks. (40 CF Sub. J) Avoid mobile fueling of mobile construction equipment around the site; rather, transport the equipment to designated fueling areas. With the exception of tracked equipment such as bulldozers and perhaps forklifts, most vehicles should be able to travel to a designated area with little lost time. Train employees and subcontractors in proper fueling and cleanup procedures.

LIMITATIONS:

Sending vehicles/equipment off-site should be done in conjunction with Stabilized Construction Entrance.

MAINTENANCE:

- ◆ Keep ample supplies of spill cleanup materials on-site.
- ◆ Inspect fueling areas and storage tanks on a regular schedule.

**DESCRIPTION:**

Vegetated buffers are areas of natural or established vegetation maintained to protect the water quality of neighboring areas. Buffer zones slow stormwater runoff, provide an area where runoff can permeate the soil, contribute to ground water recharge, and filter sediment. Slowing runoff also helps to prevent soil erosion and streambank collapse.

APPLICATIONS:

Vegetated buffers can be used in any area able to support vegetation. They are most effective and beneficial on floodplains, near wetlands, along streambanks, and on unstable slopes.

INSTALLATION/APPLICATION CRITERIA:

To establish an effective vegetative buffer, follow these guidelines:

- ◆ Make sure soils are not compacted.
- ◆ Make sure slopes are less than 5 percent unless temporary erosion control mats are also used.
- ◆ Determine buffer widths after carefully considering slope, vegetation, soils, depth to impermeable layers, runoff sediment characteristics, type and amount of pollutants, and annual rainfall.
- ◆ Make sure buffer widths increase as slope increases.
- ◆ Intermix zones of vegetation (native vegetation in particular), including grasses, deciduous and evergreen shrubs, and understory and overstory trees.
- ◆ In areas where flows are concentrated and fast, combine buffer zones with other practices such as level spreaders, infiltration areas, or diversions to prevent erosion and rilling.

LIMITATIONS:

Adequate land must be available for a vegetated buffer. If land cost is high, buffer zones might not be cost-effective. In addition, adequate vegetative cover must be maintained in the buffer to keep it effective. Vegetated buffers work well with sheet flows, but they are not appropriate for mitigating concentrated stormwater flows.

MAINTENANCE:

Keeping vegetation healthy in vegetated buffers requires routine maintenance. Depending on species, soil types, and climatic conditions, maintenance can include weed and pest control, mowing, fertilizing, liming, irrigating, and pruning.

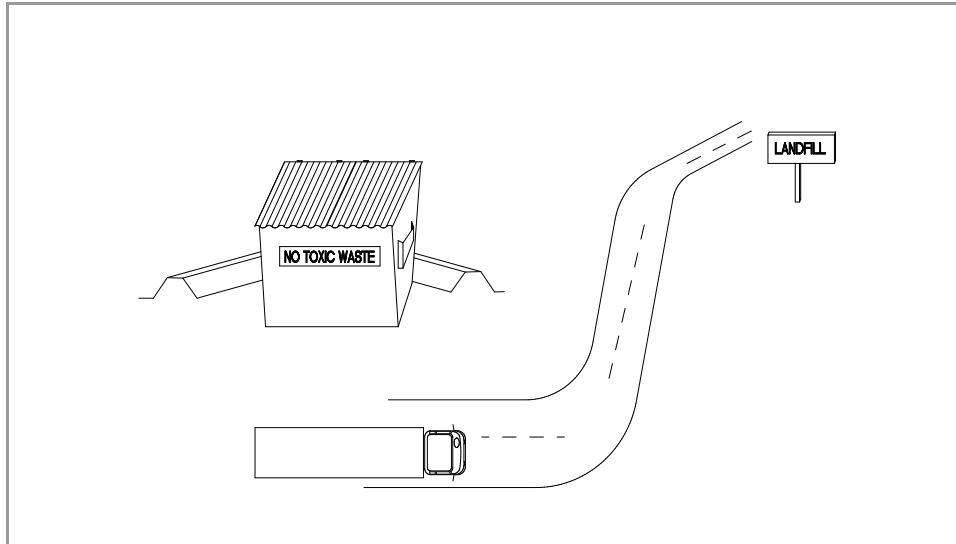
**DESCRIPTION:**

Controlled storage and disposal of solid waste generated by construction activities.

APPLICATION:

All construction sites.

INSTALLATION:

- ◆ Designate one or several waste collection areas with easy access for construction vehicles and personnel. Ensure no waterways or storm drainage inlets are located near the waste collection areas.
- ◆ Construct compacted earthen berm (See Earth Berm Barrier Information Sheet), or similar perimeter containment around collection area for impoundment in the case of spills and to trap any windblown trash.
- ◆ Use watertight containers with covers to remain closed when not in use. Provide separate containers for different waste types where appropriate and label clearly.
- ◆ Ensure all on site personnel are aware of and utilize designated waste collection area properly and for intended use only (e.g. all toxic, hazardous, or recyclable materials shall be properly disposed of separately from general construction waste).
- ◆ Arrange for periodic pickup, transfer and disposal of collected waste at an authorized disposal location. Include regular Porta-potty service in waste management activities.

LIMITATIONS:

- ◆ On-site personnel are responsible for correct disposal of waste.

MAINTENANCE:

- ◆ Discuss waste management procedures at progress meetings.
- ◆ Collect site trash daily and deposit in covered containers at designated collection areas.
- ◆ Check containers for leakage or inadequate covers and replace as needed.
- ◆ Randomly check disposed materials for any unauthorized waste (e.g. toxic materials).
- ◆ During daily site inspections check that waste is not being incorrectly disposed of on-site (e.g. burial, burning, surface discharge, discharge to storm drain).

NOTES



Salt Lake County Engineering & Flood Control
2001 South State Street, N3100
Salt Lake City, UT 84190
Phone: 801 468-2711



Remember,
WE ALL LIVE DOWNSTREAM